

Climar
L I G H T I N G

we create
the light of
tomorrow

HOSPITALITY

climarlighting.com

INDEX

INTRODUCTION	004
PRODUCT OVERVIEW	
TAILOR MADE EXAMPLES	006
STANDARD PRODUCTS	008
TAILOR MADE EXAMPLES	014
STANDARD PRODUCTS	
COLLECTIONS	052
WALL	112
SUSPENDED	124
FLOOR	158
TABLE	166
READING LIGHTS	182
RECESSED	196
EXTERIOR	204
SIGNAGE	212
MIRROR LIGHTS	216
A-Z GENERAL INDEX	222
REFERENCE PROJECTS	224



CLIMAR and its excellence

Climar Lighting has been manufacturing and supplying reliable, efficient, high-quality lighting **since 1977**.

The company is proud to boast an obsessive eye for detail and quality of finishing, combined with a pragmatic touch for simplicity of installation. **Climar Lighting** has always believed and sought to improve with a view to different lighting perceptions.

The world of **Climar Lighting** is about history, ambiance and moments that last forever through lighting projects created with wisdom and passion for details. It is culture, it is the solution that combines human vision with particular attention to the emerging requirements of the future. The company's goal is to provide the most refined and sophisticated high-quality solutions for Hospitality Ambiances.



The conviction in its expertise

In addition to the range of lighting solutions presented in the **STANDARD PRODUCTS** chapter of this catalogue, **Climar Lighting** also accept requests on a daily basis that challenge its own essence, in the search for new concepts. Those challenges lead to bespoke lighting products developed for a wide variety of spaces. Some examples of bespoke projects can be found on the **TAILOR MADE EXAMPLES** chapter of this catalogue.

Climar Lighting is dedicated to the execution of ground-breaking lighting projects based on architectural design requirements. A creation process is essentially interdisciplinary and complex, involving different professionals: **Climar Lighting team** and the **client**. Each project is crafted with authenticity and unique touch, in which each piece is a challenging and fascinating venture.

Climar commits itself to the impossible, with a conviction in its expertise.



TAILOR MADE EXAMPLES



DIMPLE

PAG 016



CUBO

PAG 018



SATURNO

PAG 020



MOQ

KOBBER-02

PAG 022



MOQ

KOBBER-03

PAG 024



MOQ

POP-UP

PAG 026

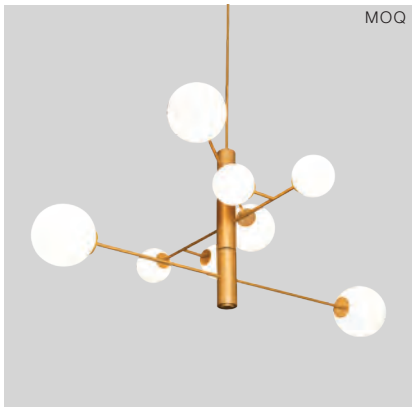

MOQ

AMELIE

PAG 028



MOQ

DYNASTY

PAG 030



MOQ

LUSH

PAG 032

TAILOR MADE EXAMPLES



GOCCIA

PAG 034



DREAM

PAG 036



CRISTAL LOVE

PAG 038



QUEEN

PAG 040



DIAMOND

PAG 042



SOLARIS

PAG 044



CYLIX

PAG 046



ANAHORY

PAG 048

STANDARD PRODUCTS

COLLECTIONS



SYN PAG 054



NIU PAG 058



NOA PAG 062



SPHERE PAG 068



MOQ

RUBY PAG 072



MOQ

DOURO PAG 076



MOQ

STYLUZ PAG 080



MOQ

TR3 PAG 084



MOQ

KRIZ PAG 088



MOQ

ARCH PAG 090



MOQ

SPAZZO PAG 092



MOQ

VERSITY PAG 094



MOQ

CIVETTA PAG 096



MOQ

MELI PAG 098



MOQ

EVA PAG 100



MOQ

GRATIA PAG 102

STANDARD PRODUCTS



NATUR PAG 104



CHERRY PAG 106



MUSE PAG 108



FLEX PAG 110

WALL



STONE PAG 114



LEAF PAG 116



POZI PAG 118



CHESS PAG 120



WAVE PAG 122

STANDARD PRODUCTS

SUSPENDED

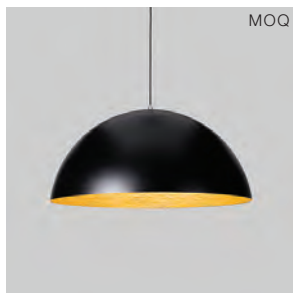

ROCHÉ PAG 126



FLOWIN PAG 128



COCO PAG 130

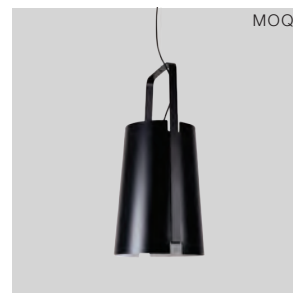

GRANDI PAG 132



TABRIGA PAG 134



RAY PAG 136



VOID PAG 138



GARLAND PAG 140



SPELL PAG 142



EDGY PAG 144



CONE PAG 146



TORCH PAG 148



FIORI PAG 150



GALERIA PAG 152



MEET PAG 154



ECO PAG 156

STANDARD PRODUCTS

FLOOR



MOQ

SCAPES

PAG 160

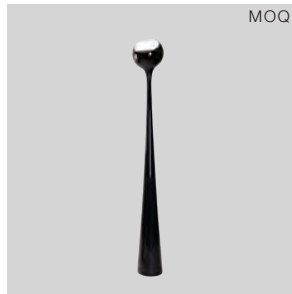

MOQ

SNUPY

PAG 162



MOQ

SUNSET

PAG 164

TABLE



MOQ

KLLAVE

PAG 168



MOQ

SWIRL

PAG 170



MOQ

BONN-01

PAG 172



MOQ

BONN-02

PAG 174

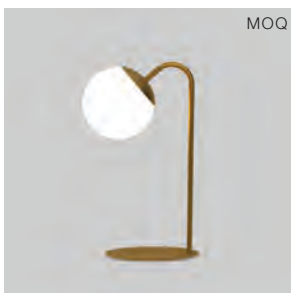

MOQ

DUNE

PAG 176



MOQ

LINEFLUX

PAG 178



MOQ

SANTIAGO

PAG 180

STANDARD PRODUCTS

READING LIGHTS



FLEXILED PAG 184



SOFTLED SF PAG 186



SOFTLED RC PAG 188



SOFTLED RO PAG 190



STAR PAG 192



TAP PAG 194

RECESSED



JAZZ PAG 198



KNIK PAG 200



O-LIGHT PAG 202

STANDARD PRODUCTS

EXTERIOR



TREE PAG 206



LUNA PAG 208



TEPLUS PAG 210

SIGNAGE



SIGNAGE 150 PAG 214

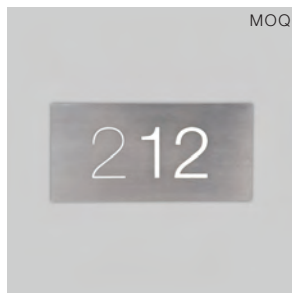

SIGNAGE 210 PAG 214

MIRROR LIGHTS



LINEAR SHAPE PAG 218



CURVE SHAPE PAG 218

TAILOR MADE EXAMPLES

BYBEAU'S DIMPLE

DESIGN BY BYBEAU

Finding the right light.

DIMPLE was designed by Beau McClellan and manufactured by Climar Lighting for ByBeau. It is the natural progression, the application and adaptation of what we had learnt to fit other situations. Inspiration-creation-inspiration. Necessity may well be the mother of invention - but sometimes invention can prove to have maternal instincts of her own.



DIMPLE BY BYBEAU

Total freedom of imagination.

A distillation of the spirit and inspiration of our previous works, DIMPLE has been refined to allow for total freedom of imagination. As sensitive to the personality of a space or client as it is to the light of its surroundings, it offers a flexible, modular chandelier system to suit interiors of all sizes - starting from a single pendant through to flowing cascades of individual drops. Allowing a personal exploration of the space, aesthetic and feel of an environment.

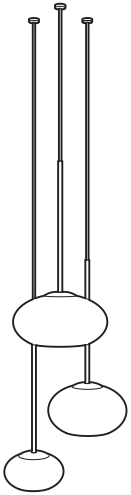

Designed for stage, perfect for home.

This ByBeau product offers a truly exclusive experience with complete freedom to customise your design, **every drop** of the chandelier can be configured with a separate **RGBW LED** chip, providing either a single warm white or combination of natural whites where desired. Each of these drops can then be individually controlled via **DMX** to provide a fully personalised, reactive display. It's designed to be flexible, working either with its own control system or with an other already installed.



DIMPLE BY BYBEAU



Mesmerizing lights, suspended at the sky.

When switched on, the unique, pioneering two-way **mirror-coated finish** - available in chrome - unveils an extra interior **hand-blown glass** ball. This playful approach to the interweaving of art and light captures the whimsy of imagination; transitioning throughout the day, providing a magical twist to the character and narrative of an environment.

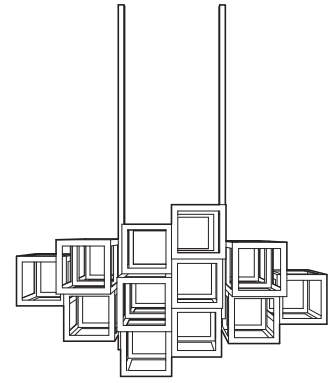

Impressive talent.

By bringing together the best know-how from different areas, each project is adapted and manufactured by hand, keeping in mind the clients' needs and wishes. Exclusivity is a reflection of the professionalism that is practiced. The creation process focuses on the employees' efforts, who, in every work, combine the best of each one, obtaining refined solutions in terms of aesthetics, with a refined functional sense.

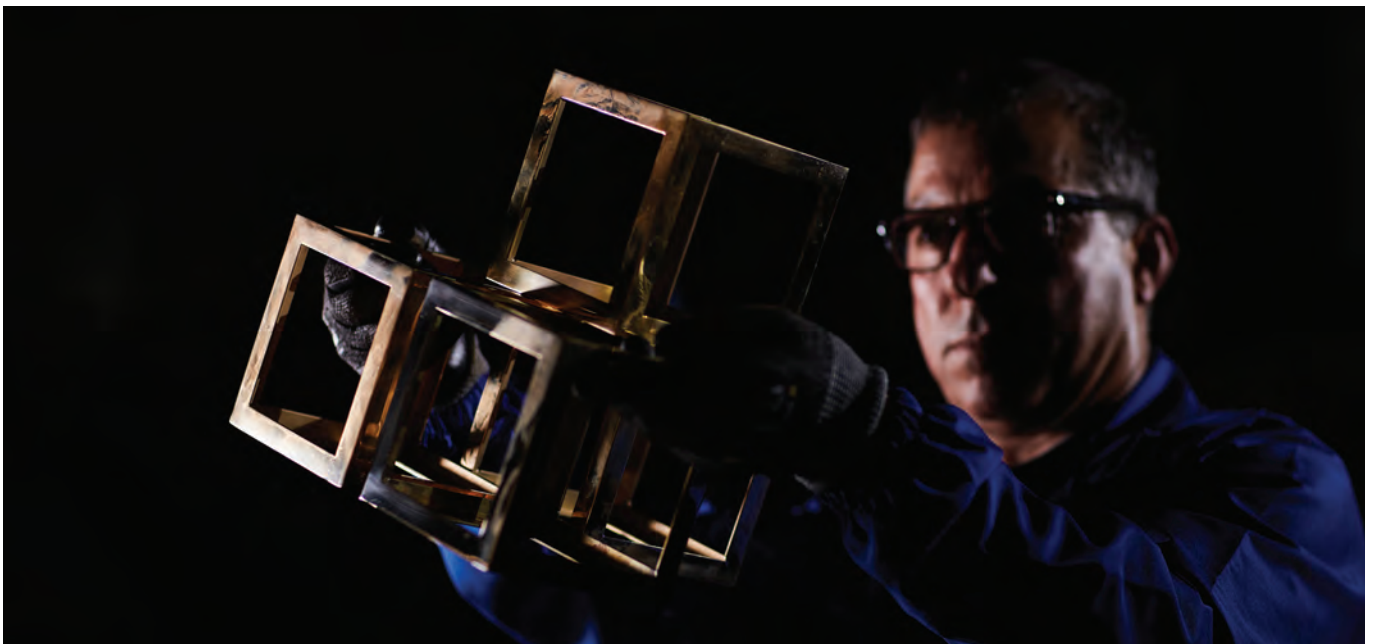



CUBO

DESIGN BY **BEAU MCCLELLAN** AND **BYBEAU** TEAM

Creative vision.

In a classic Portuguese-style environment, light illuminates a path full of stories with a unique authenticity. Offering glimpses of this world, with harmonious touches and details of modern luxury, the concept was conceived by the creative, bold and talented designer Beau McClellan and his team at ByBeau Studio.

Elegance in the making.

The design of this lamp is based on cubic geometric forms that bring together new lighting concepts. The duality between the **matt and high-gloss finishes** result in an elaborate composition that embodies a deconstruction of the modules, frozen in time. Through the nobility of brass, the end result presents a perfect symbiosis between light and shadow.



SATURNO



Whenever
is required a
distinct design.

This is the ideal time to fall in love with simple lines and bronze hues. The piece brings out a touch of desire in the space, asserting itself as a stately piece with distinct uniqueness. Ideal for prominent spaces, restaurants, bars or hotel lobbies.



PROJECT

Hotel EPIC Sana
Luanda - Angola

DESIGN

Climar Lighting

Surface mounted luminaire composed of **10 rings**, with measures between **Ø600mm** and **Ø1800mm**, in **aluminium** painted in **bronze**, with **60W** total power. Chandelier overall dimensions **Ø1800mm** with **2570mm** height.

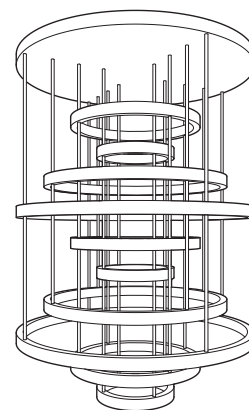



KOBBER-02

Orbiting copper rings of light.

Imposing chandelier with three magnificent rings and lighting flowing from small light points. All the copper rings are linked together to form a unique shape, that can be transformed by slightly rotating each ring. The varnished finish gives this copper chandelier a true sense of luxury. This bespoke chandelier can be customised to fit your interior design project.



PROJECT

Adega Vale D'Algarés
Vila Chã de Ourique - Portugal

DESIGN

Climar Lighting

MOQ - Minimum Order Quantity
2 units

Suspended luminaire
composed of **3 orbiting**
rings, Ø1400mm,
Ø1500mm and Ø1600mm
measures, in **varnished**
copper, with **278 G9 LED**
lamps of 40W maximum
power.

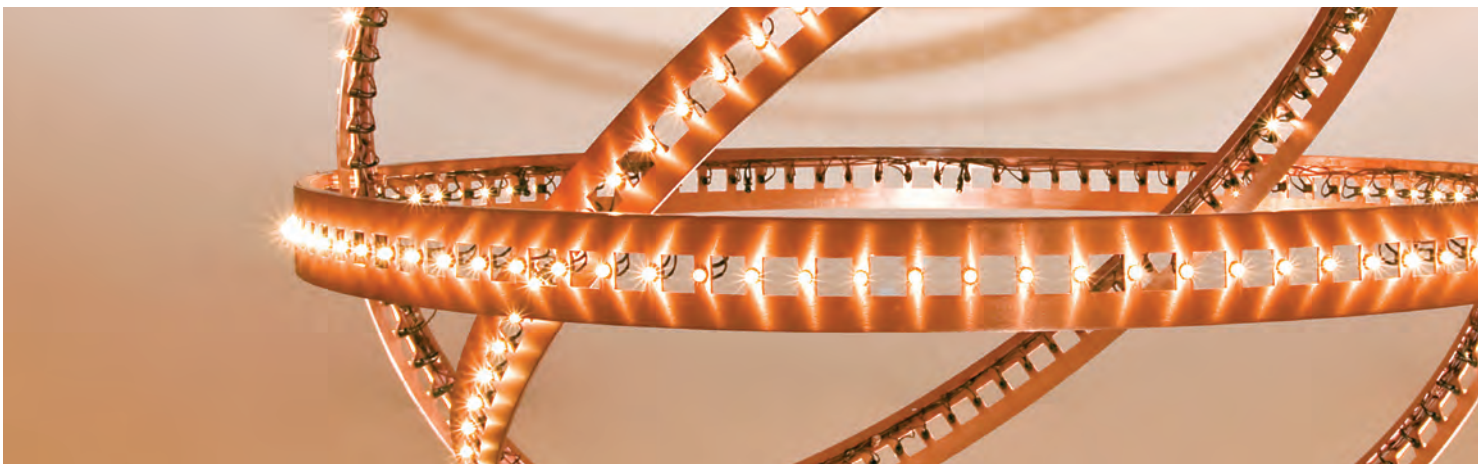
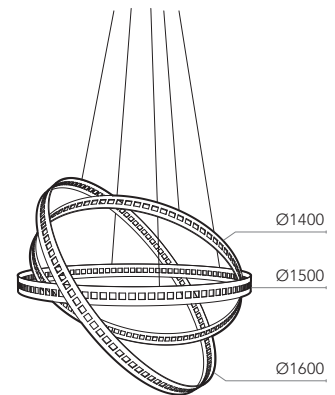



**PROJECT**

Adega Vale D'Algares
Vila Chã de Ourique - Portugal

DESIGN

Climar Lighting

MOQ - Minimum Order Quantity
2 units

KOBBER-03

Suspended luminaire composed of **3 horizontal rings**, **Ø1000mm**, **Ø1500mm** and **Ø2000mm** measures, in **varnished copper**, with **280 G9 LED lamps** of **40W** maximum power. Chandelier total height is **2000mm**.

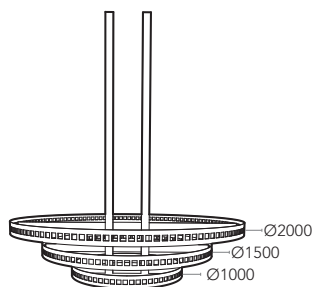

Imposing rings of light.

KOBBER circular chandelier is composed by three rings with lighting flowing from small light points. With a varnished copper finishing, this bespoke chandelier can be customised to fit your interior design project. A true example of high-quality craftsmanship, this classic chandelier features three parallel rings and an extremely balanced design.

Ideal to use as a modern dining room lighting fixture or as entrance lighting.

POP-UP



It pops into your eyes.

Chandelier combining design with the aged brass finish to generate the lighting that accentuates, differentiates and enhances the character of any room. Characterized by a handmade structure with brass tubes carefully combined to form a geometric design. With 84 tubes arranged in a rhythmic pattern and an extremely balanced design, this classic lighting design gets even more beautiful when you see the light flowing from its tubes. This luxurious chandelier is ideal for refined living rooms or grand halls.



PROJECT

L'Oréal Paris
Lisboa - Portugal

DESIGN

Climar Lighting

MOQ - Minimum Order Quantity
3 units

Suspended luminaire composed of **84 tubes**, measuring **Ø63mm**, in aged **brushed brass**, with **13 E27 LED lamps** of **60W** maximum power.

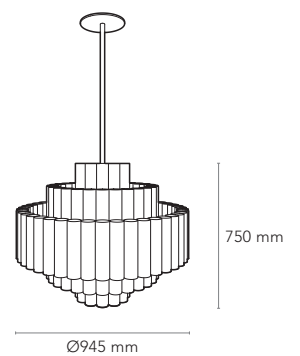

AMELIE



Balance and Elegance.

AMELIE suspension lamp is a very functional lighting that will add beauty and a classical touch to your interior design. Handmade in aluminium, the body is covered by a gold finish with opal glass globes providing soft diffused light. Ideal to use as a dining room lighting fixture or as an entrance lighting, AMELIE has a special appeal that won't go unnoticed.

**DESIGN**

Climar Lighting

MOQ - Minimum Order Quantity
4 units

Suspended luminaire composed of **3 horizontal arms**, in **aluminium** painted in **golden colour**. With **opal glass** spherical elements with measures of **Ø140mm**, and **Ø200mm**, illuminated with **8 G9 LED lamps** of **40W** maximum power. Chandelier total height of **1610mm**.

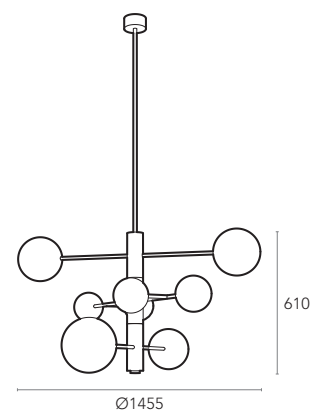



DESIGN

Climar Lighting

MOQ - Minimum Order Quantity
3 units

Suspended luminaire composed of **3 grouped modules**, in **aluminium** painted in **golden colour**. With **opal and crystal PMMA** diffuser, illuminated with **LED technology**, with temperatures of **2700K, 3000K or 4000K** and **105W (3x35W)** total power.

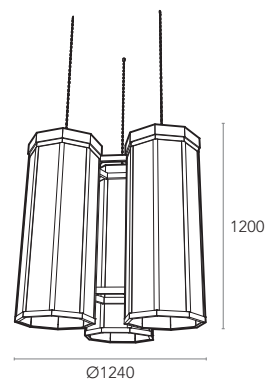

DYNASTY



Decorative Trilogy.

Imposing chandelier with three suspended elements in an exuberant combination.

The aluminium structure covered by a gold-plated finish gives the chandelier a true sense of luxury. Since it is a bespoke lighting design, every feature can be altered to meet your expectations and requests. DYNASTY is the perfect lighting fixture for the entrance of a luxurious hotel or framed in a wide space.

LUSH

All majestic places deserve lux.

Bespoke chandelier with handmade structure in stainless steel and an intricate design pattern, covered by a chrome or gold-plated finish. The silk lampshade is fitted with an opal diffuser for homogeneous light emission and comfortable environments. It's possible to customize this suspension lighting in any shape, dimension or finish, as well as in the texture and colour of the lampshade, to give each environment a reassuring and unique identity. LUSH is the perfect customisable chandelier for a luxurious lobby at a five-star hotel.



**PROJECT**

Hotel Conrad
Quinta do Lago - Portugal

DESIGN

Climar Lighting

MOQ - Minimum Order Quantity

4 units

Suspended luminaire composed of an **oval chrome exterior structure**, with an exclusive pattern, and a **white pongé silk lampshade** centre, illuminated with **8 E27 LED lamps** of **60W** maximum power.

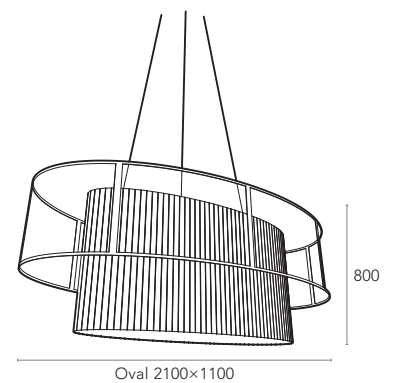

GOCCIA

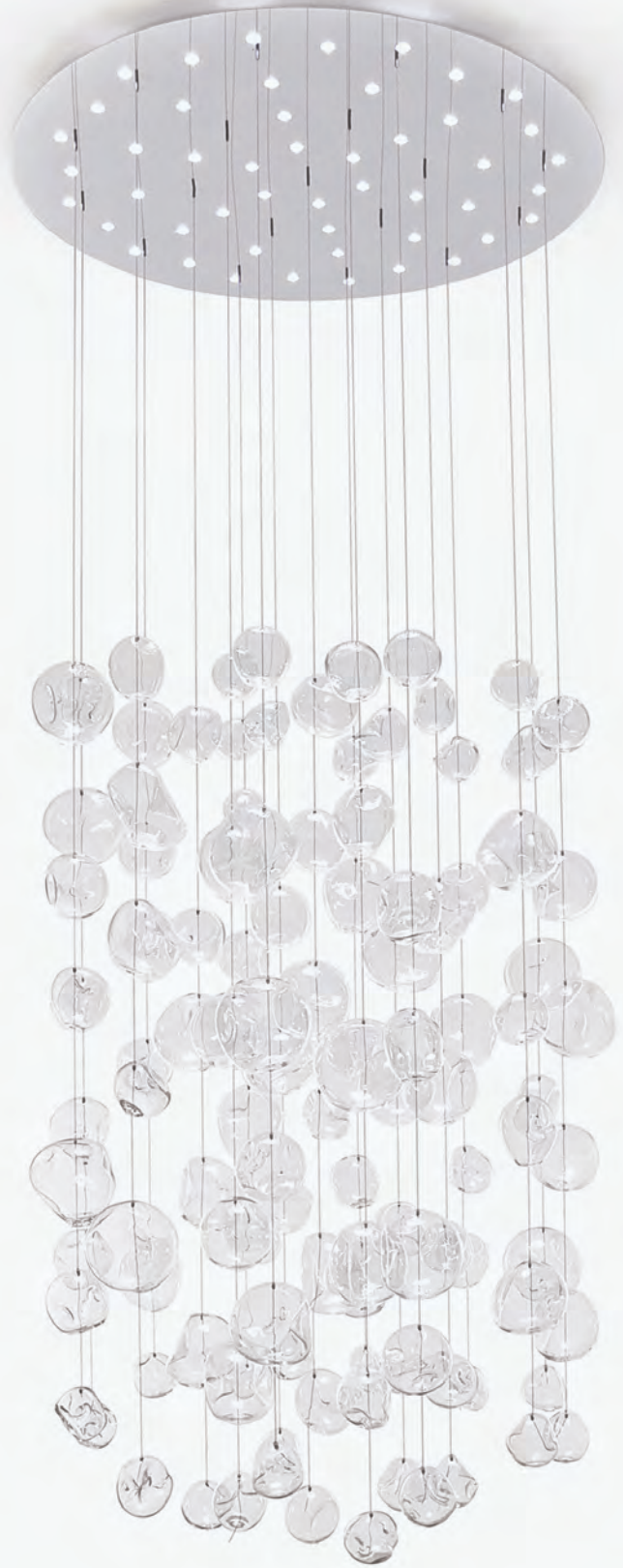

Glass in its most organic form.

Extremely elegant and exuberant chandelier. With a stainless steel plate as support, this piece consists of randomly suspended glass balls, all different as a result of the manual glass blowing process employed. All the brightness of the piece is struck in the impact of the LED light in the glass balls, creating beautiful visual games of light. A true example of high-quality craftsmanship, GOCCIA is a bespoke lighting design where every feature can be altered to meet your expectations and requests. GOCCIA has the potential to become the centrepiece in large spaces with high ceilings.

**PROJECT**

Isabel Castro Cabeleireiros
Aveiro - Portugal

DESIGN

Climar Lighting

Surface mounted luminaire composed of a **chrome structure**, illuminated with **72 LED technology spots** with a **5000K** colour temperature and **144W** total power. Suspended to the structure are steel cables with hand-blown **crystal glass balls** with three organic dimensions ($\text{Ø}140$, $\text{Ø}200$, $\text{Ø}250\text{mm}$) that produce several light reflections.

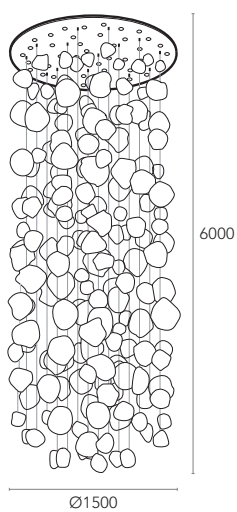
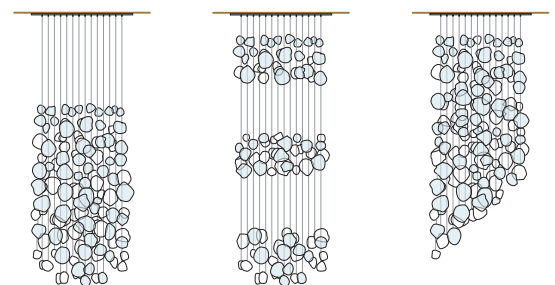
**ARRANGEMENTS**

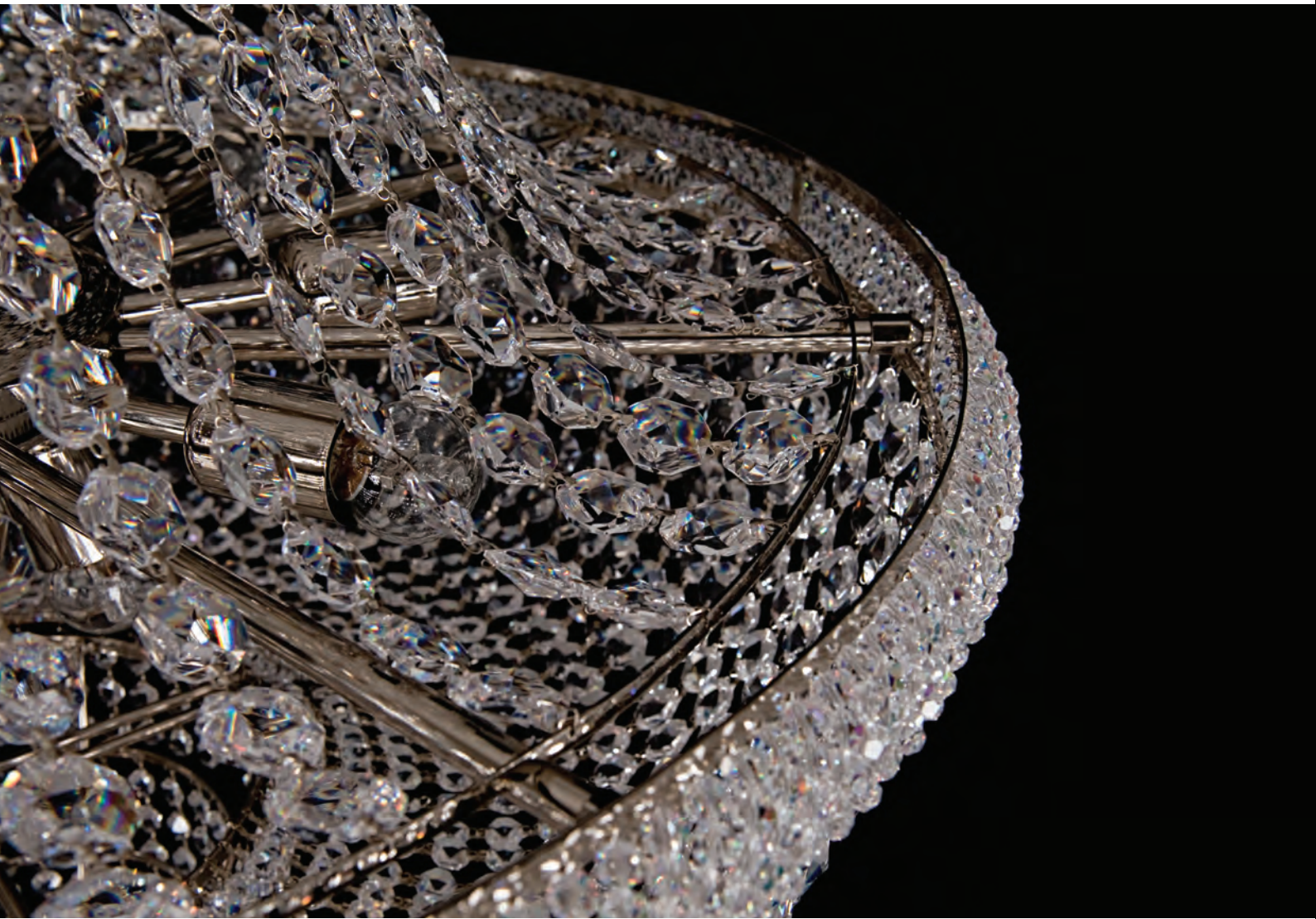

DESIGN

Climar Lighting

Suspended luminaire composed of a **chrome-plated brass structure**, illuminated with **24 E27 LED lamps of 60W** maximum power. Attached to the structure are **crystal glass** chains that give shape to the chandelier and produce distinct light reflections.

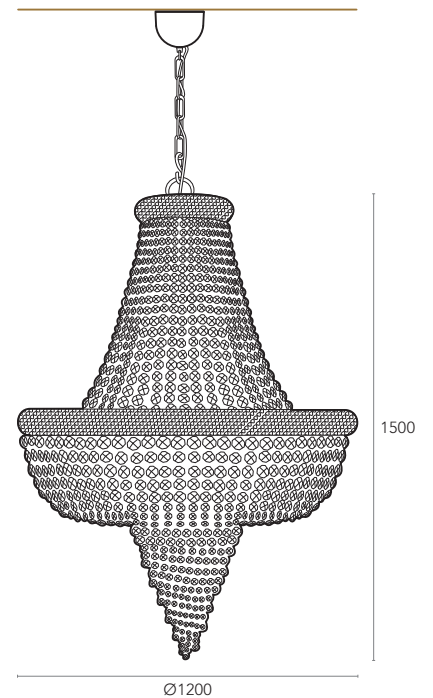

DREAM



Elegance and exuberance.

DREAM chandelier is a striking blend of vintage elegance and bold silhouettes. The chrome plated brass frame is draped in cascades of shimmering precision cut glass crystals of different sizes and shapes which reflect the lights beautifully for a glamorous elegance. Chrome ceiling cup with high strength chain suspension that can be adjusted for different ceiling heights. A true example of high-quality craftsmanship, this classic chandelier will make a magnificent centre piece to any large living room or hallway.

CRISTAL LOVE

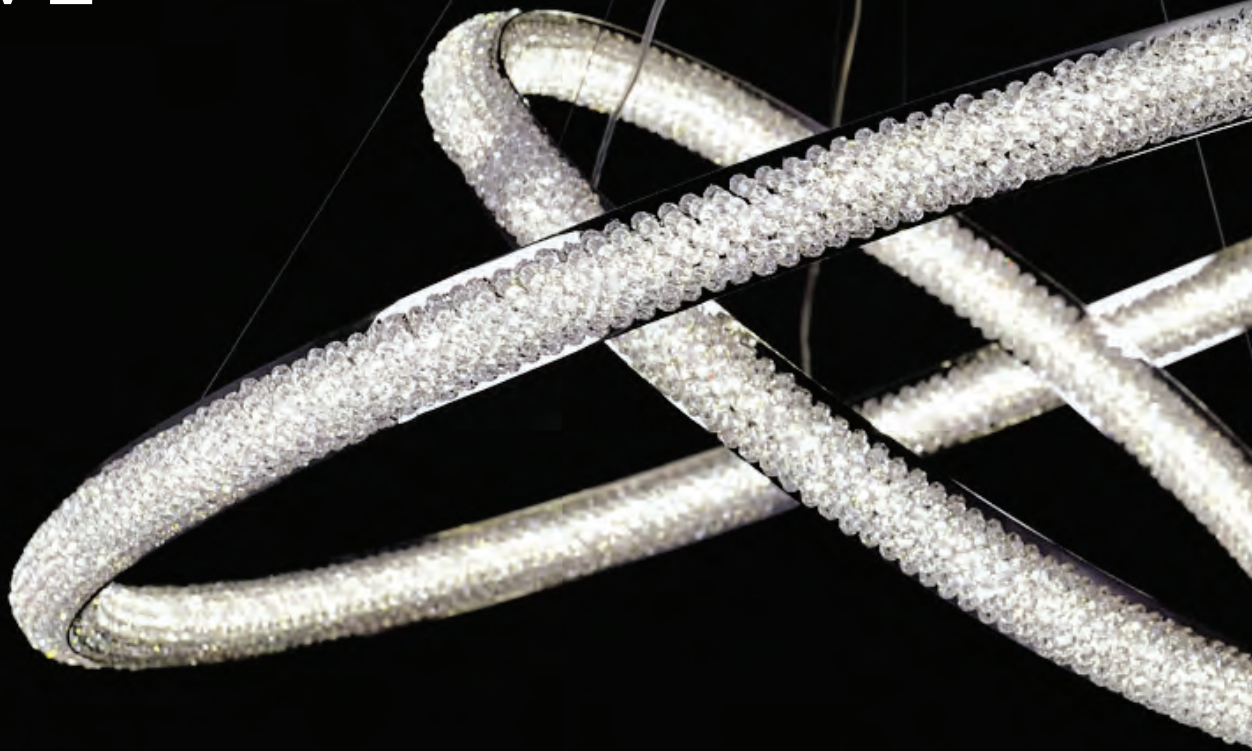

Combining elegance, simplicity and technology.

CRISTAL LOVE creates a design statement for contemporary and traditional interiors. This pendant lamp is characterized by the perfect fusion of materials as varied as crystals mounted on a chromed plated brass structure and LED lighting. The elegance and exuberance of the luminaire arise from the randomly suspended light rings in unobtrusive steel cables and the ability to be used either individually or in combination of several rings. CRISTAL LOVE is an exquisite handmade pendant lamp suited for the most luxurious settings.

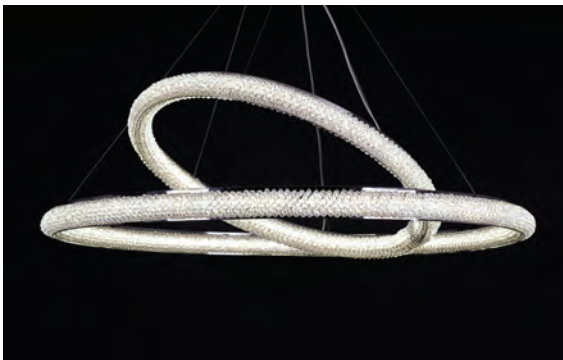

DESIGN

Climar Lighting

MOQ - Minimum Order Quantity
4 units

Suspended luminaire composed of a **chrome-plated brass ring**, illuminated with **LED technology** of **4000K** or **5000K** colour temperatures and **52W** ($\varnothing 600\text{mm}$) or **92W** ($\varnothing 1000\text{mm}$) total power. Attached to the ring are **crystal glass** chains.

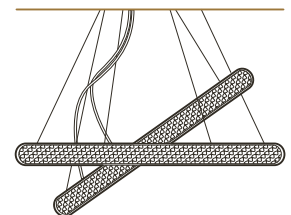
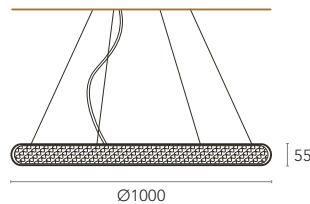
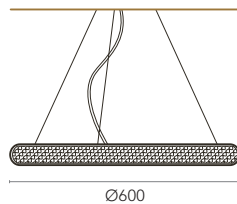

QUEEN



An origami of light.

Irregular hexagonally shaped lamp, marked by asymmetrical sharp edges. With a design inspired by origami – the Japanese art of paper folding – this striking multi-faceted pendant lamp emits light at fascinating angles from its many surfaces. Bicoloured finish lamp shade with matt white interior, enhancing the lighting design with a perfect mix of form and function. The homogeneous direct and indirect light distribution will make this unique lighting design suitable to be used in a modern living room design or as a modern dining room lighting.



PROJECT

Academia de Ginástica de
Guimarães - Portugal

DESIGN

Climar Lighting

MOQ - Minimum Order Quantity
4 units

Suspended luminaire composed of a **hexagonal structure**, in **aluminium** painted in **black** and **white**, and the centre in **opal PC**, illuminated with **LED technology** of colour temperature **4000K** and **28W** total power.

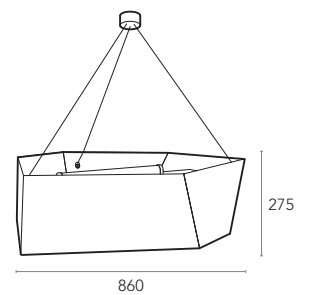



DESIGN
Climar Lighting

MOQ - Minimum Order Quantity
3 units

Surface mounted luminaire composed of a **chrome structure**, where are fixed **10 arms** that shape the chandelier, illuminated with **276** points of **LED technology** with colour temperatures **3000K, 4000K or 5000K** and **276W** total power.

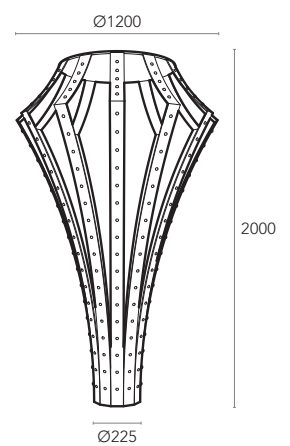

DIAMOND



**Shiny like
a diamond.**

Sculptural ceiling lamp with very unique details that will certainly capture the attention.

This memorable lamp features a chromed finish that combines perfectly with the small LED light points for a true sense of luxury. The stainless steel structure is entirely shaped and assembled by hand. This lighting fixture is the perfect choice for a modern entrance as well as a statement lighting design in a hospitality project.

SOLARIS



Exquisite piece, a fairy tale chandelier.

Like something from a fairy tale or from the bottom of the ocean here is SOLARIS. With its unique shape, this exquisite chandelier is entirely made of hand blown glass, a true example of high-quality craftsmanship. It is a memorable lighting fixture, with very unique details that make it the luxurious bespoke design piece that it is. SOLARIS chandelier will certainly capture the attention of your guests.



DESIGN

Climar Lighting

MOQ - Minimum Order Quantity
4 units

Suspended luminaire composed of an **aluminium** base structure and **41 arms** with **coloured glass** finishing, which give the chandelier a sun shape, illuminated with **40 G9 LED lamps** of **40W** maximum power.

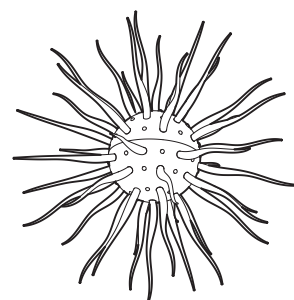

Ø1400

PROJECT

Forum Barreiro
Lisboa - Portugal

DESIGN

Climar Lighting

MOQ - Minimum Order Quantity
6 units

Suspended luminaire composed of an **aluminium** structure painted in **black**. With **opal PC** diffuser, illuminated with **LED technology**, with colour temperature **4000K** and **142W** total power.

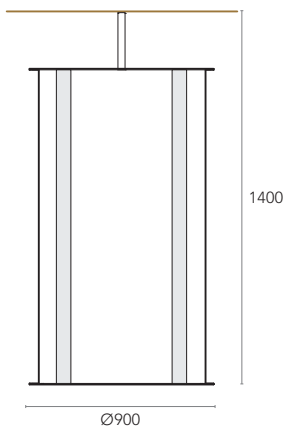

CYLIX



Simple design with a lot of character.

CYLIX was designed to flood the room with subtle light and cleverly combines understated glamour with stunning design. Voluminous pendant lamp characterized by a handmade structure fitted with curved translucent panels which create exquisite light effects, further enhancing its shape. The varnished standard finish gives the lamp a true sense of luxury, however the finishes can be customised with any other metal or colour to fit your project. CYLIX is the perfect lighting for a luxurious lobby at a five-star hotel, but it also looks amazing in a grand dining hall.

ANAHORY

DESIGN BY JOSÉ AMARAL ANAHORY

Curvy organic, natural forms.

With delicate and curved forms, this unique lighting design was created to be a strong statement piece that cannot go unnoticed wherever it's placed. It is characterized by a stainless steel structure, entirely shaped and assembled by hand, wrapped in a special opaque Lycra. Sizes and colours can be customised upon request to fit your interior design concept. With an extremely balanced design, these sculptural lamps get even more beautiful with the ambient light being casted in all directions. ANAHORY will definitely make a statement in a classic and luxurious hospitality project.





PROJECT

The Oitavos
Cascais - Portugal

DESIGN

José Amaral Anahory

MOQ - Minimum Order Quantity
20 units

Family of **floor** or **table** luminaires composed of **brushed stainless-steel** structure with **anti-reflective lycra** coating. Table and Floor products illuminated with **E27 LED lamps of 60W** maximum power. Floor XL product illuminated with **3 E27 LED lamps of 60W** maximum power.

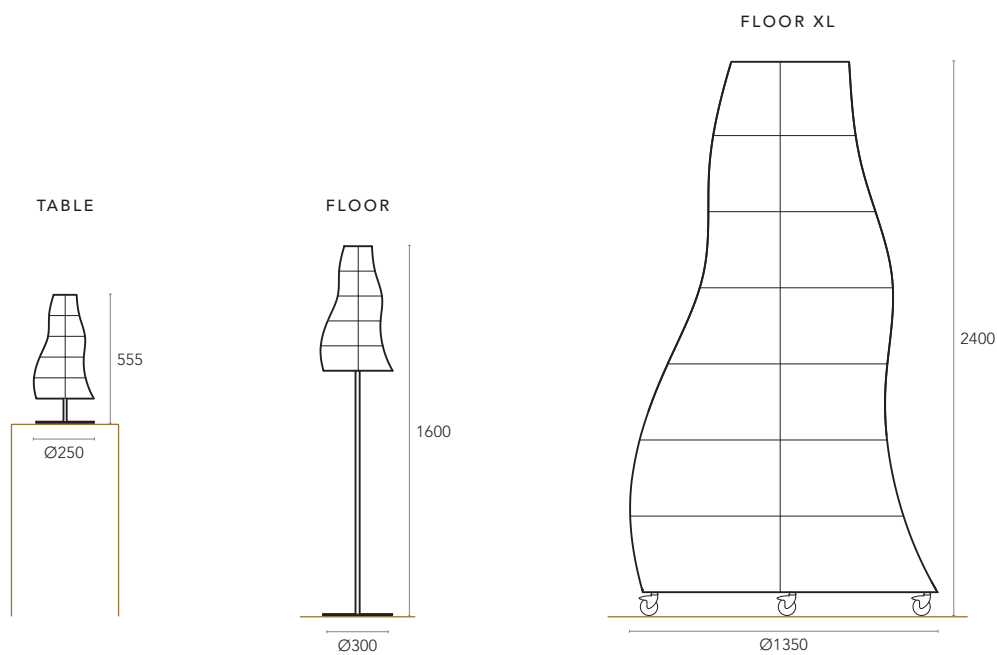

STANDARD PRODUCTS



COLLECTIONS

SYN

Primal sin,
minimalist and elegant.

The perfect blend of cutting-edge technology and clean lines to create exceptionally flexible situation-based lighting designs. SYN has the choice of distinct versions and different light effects, all producing brilliant, glare-free light for a unique lighting experience. SYN luminaire series integrates brilliantly into a wide variety of room and lighting concepts in the private and commercial sectors. It is available in several standard finishes, which can be customised to any RAL colour of your choosing. Thanks to the latest LED technology it guarantees energy-efficient implementation of all concepts.





SYN





FEATURES

MOUNTING

Wall
Table
Floor

LIGHT SOURCE

LED
3000K, 4000K

WALL

8W – Indirect & Direct Light

TABLE

6W – Direct Light

FLOOR

6W – Direct Light
8W – Indirect & Direct Light

CONTROL

On/Off
Bluetooth

MATERIALS & FINISHING

STAINLESS STEEL BODY

- Chrome PVD
- Copper PVD

ALUMINIUM BODY

- Matt White
- Matt Black

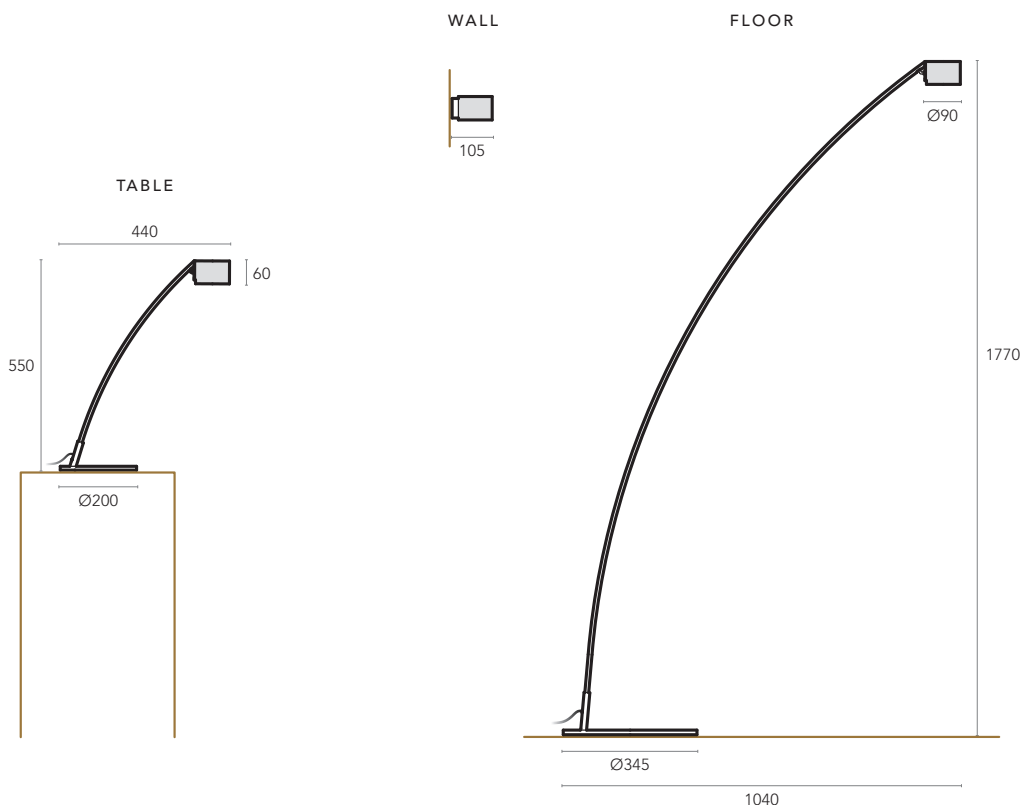

ALL DIMENSIONS IN MILLIMETERS

NIU

Every teardrop
is a waterfall.

Beautifully simple and elegant, with a voluminous teardrop shape crafted from smoked glass, the NIU family of lamps will surely create an atmospheric glow in any space. The clean lines and graceful proportions of the teardrop allows the light to “breathe” through a blown glass shade creating wonderful effects, while the PVD coated base give an elegant and sophisticated final touch. NIU is a collection of flexible mounting options with a custom feel, consisting of ceiling, wall, table and floor versions, enabling comprehensive lighting design for the living and office environment.





011





FEATURES

MOUNTING

- Suspended
- Surface
- Wall
- Table
- Floor

LIGHT SOURCE

- E27
- 1 × MAX 60W

MATERIALS & FINISHING

GLASS SHAPE

- Smoked Glass

STAINLESS STEEL BODY

- Chrome PVD
- Cooper PVD

MIN

SUSPENDED

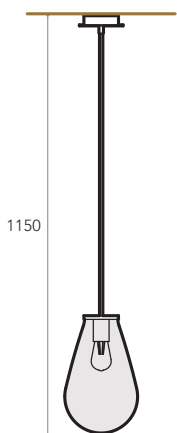

SURFACE

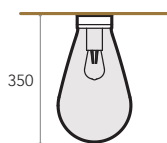

WALL

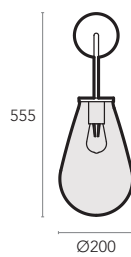

TABLE

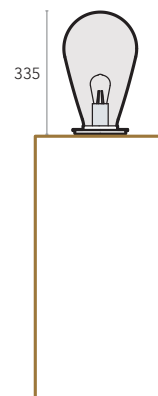

FLOOR

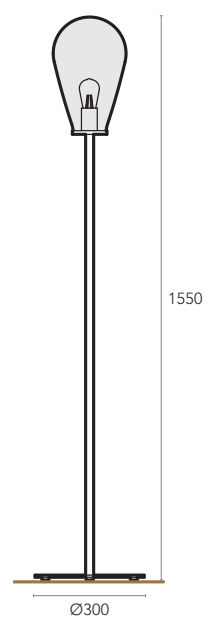

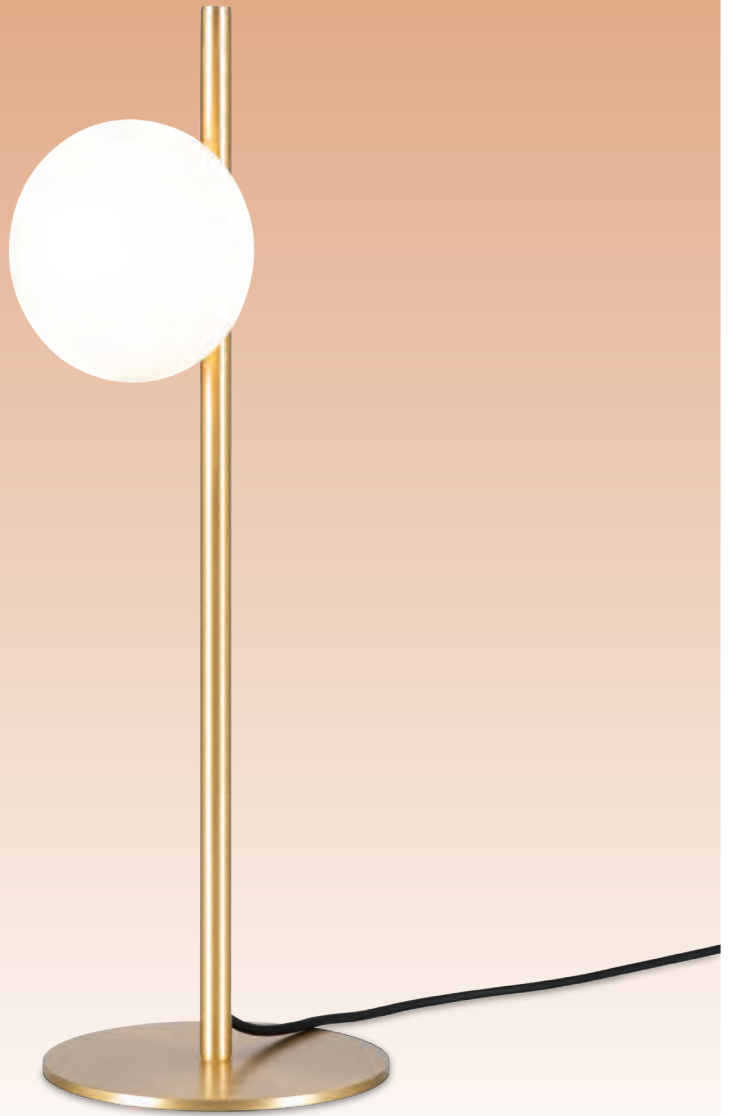

NOA

The beauty
of simplicity.

Unites timeless design with simplicity and functionality in one comprehensive system. From the soft diffused light of the opal glass globes to the simplicity of its handmade structures, this luminaire series is consistent in its design and light quality, while providing optimal light solutions for every situation. It is available in a wide range of versions and with a variety of finishes. NOA easily integrates into any modern style decor in residential and public environments.



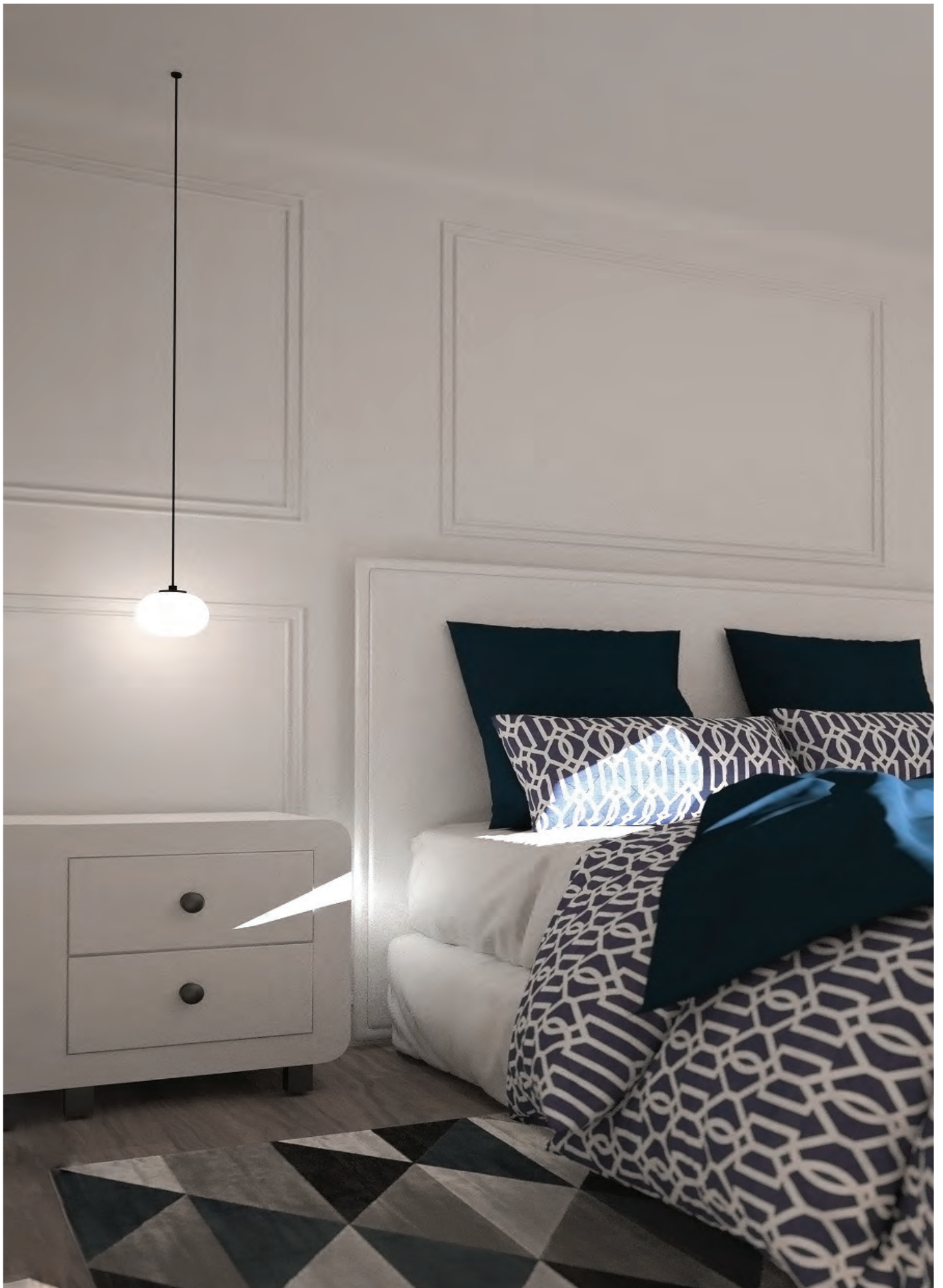





FEATURES

MOUNTING

Suspended
Wall
Table
Floor

LIGHT SOURCE

LED
3000K, 4000K
1×5W, 2×5W, 3×5W
Small C. Cup - External Driver

CONTROL

On/Off
Bluetooth

MATERIALS & FINISHING

BRASS BODY

- Chrome
- Brushed Brass

ALUMINIUM BODY

- Matt White
- Matt Black

GLASS GLOBE

- Opal Glass

GLASS GLOBE

SMALL



MEDIUM

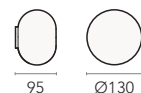

LARGE

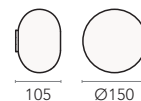

All standard globes can be applied on each model.

SUSPENDED

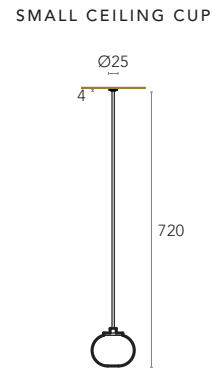
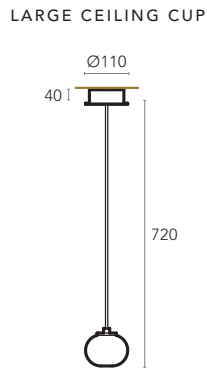
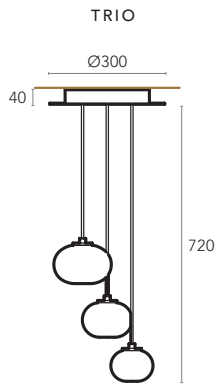

WALL 1

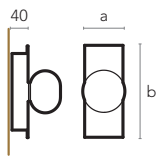

WALL 2



WALL 3

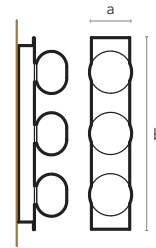

Globe

- Small
- Medium
- Large

a × b
110 × 240
130 × 280
150 × 320

a × b
110 × 340
130 × 380
150 × 420

a × b
110 × 500
130 × 540
150 × 580

TABLE

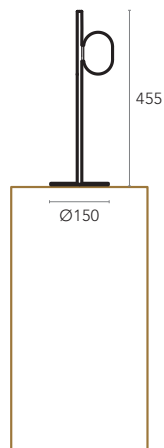

FLOOR

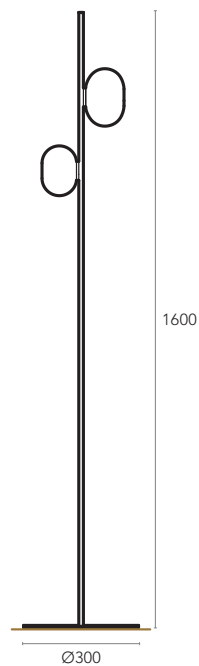



SPHERE

**Radiant light,
delicate balance.**

SPHERE collection is a timeless design that will add beauty and a classical touch to your interior design. Composed by an opal glass globe and a brass structure with a warm brushed finish for a true sense of luxury, however the finishes can be customised with any other metal of your choosing. A lighting design based on an opal glass globe providing soft diffused lighting as well as a sense of serene calm to any hallway, living room, or bedroom.







SPHERE

SUSPENDED

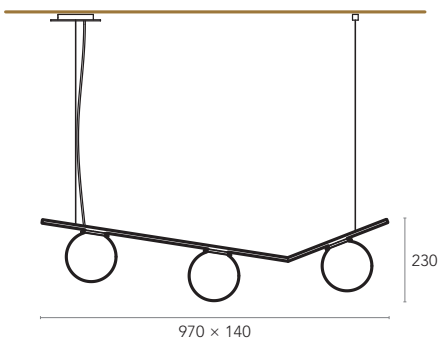

WALL

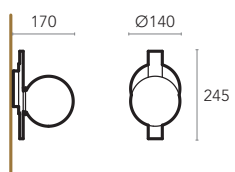

TABLE

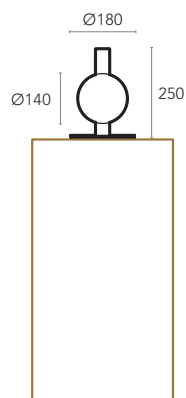

FLOOR

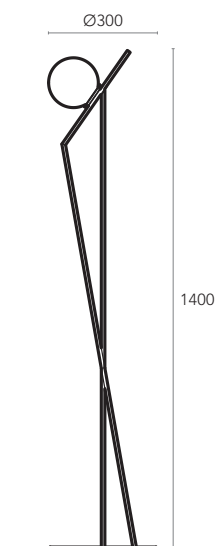

FEATURES

MOUNTING

Suspended
Wall
Table
Floor

LIGHT SOURCE

G9
Suspended – 3× MAX 40W
Wall – 1× MAX 40W
Table – 1× MAX 40W
Floor – 1× MAX 40W

MATERIALS & FINISHING

BRASS BODY
● Brushed Brass
GLASS GLOBE
○ Opal Glass



RUBY



DESIGN BY ALBINO MIRANDA

A jewel from the earth.

RUBY is characterized by a unique design, making it imposing as well as bold, suited for the most distinct rooms. Its majestic style, fully adaptable to any interior design, harmoniously combines the fibreglass handmade lampshade with a brushed brass or matt black coated structure. With a sculptural shape and an appeal that won't go unnoticed, the lampshade gets even more beautiful when you see the exquisite light effects created by the fibreglass texture. RUBY collection is the perfect lighting design for the most luxurious settings you can think of.





SUSPENDED

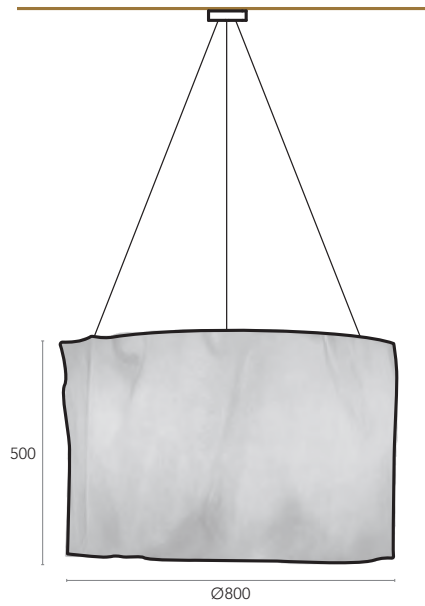

FEATURES

MOUNTING

Suspended
Table
Floor

LIGHT SOURCE

E27
Suspended – 3× MAX 60W
Table – 1× MAX 60W
Floor – 3× MAX 60W

MATERIALS & FINISHING

BRASS BODY

Brushed Brass

LAMPSHADE

Translucid Fiberglass

MOQ - Minimum Order Quantity
6 units

FLOOR

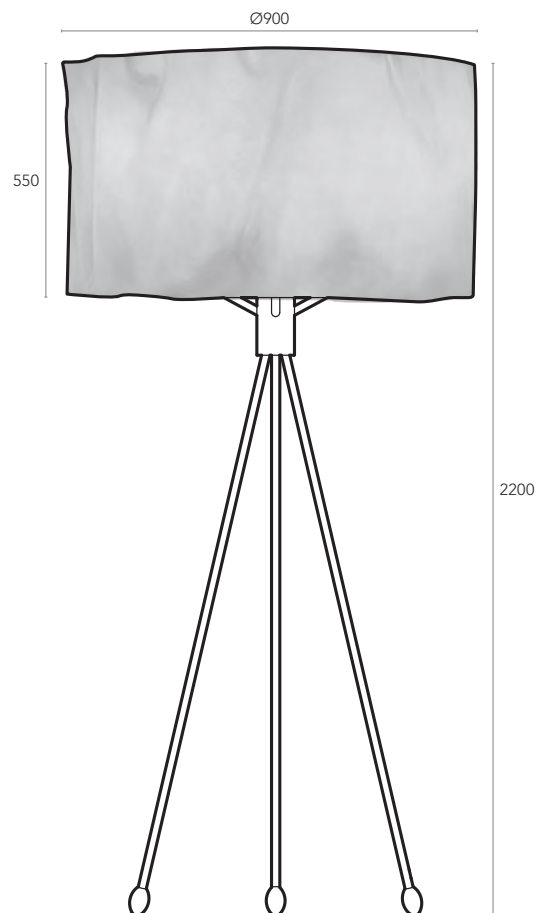

TABLE

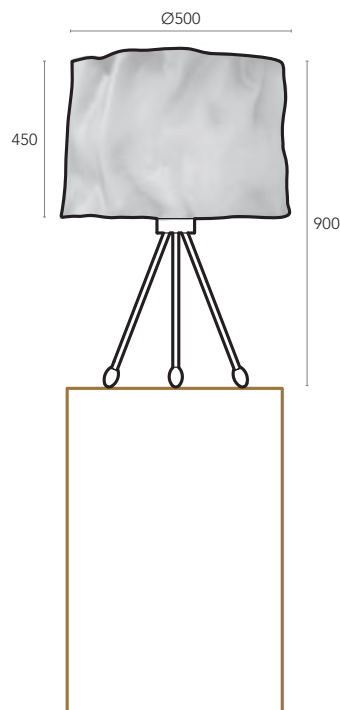

RUBY

DOURO

DOURO

DESIGN BY ÁLVARO SIZA

Unique style with an inspiring and comfortable light.

Expressive contemporary collection with minimalist modern lines elegantly blending simplicity with LED technology. The DOURO product line has a stylistic purity that has been designed to ensure a strong architectural presence, while creating relaxed and warm atmospheres in hotels, restaurants and indoor walkthrough areas. Featuring a minimalist design that perfectly suits contemporary interior design concepts, this exquisite collection is entirely handmade in aluminium and is available in a range of designs and sizes.





DOURO





AP-5

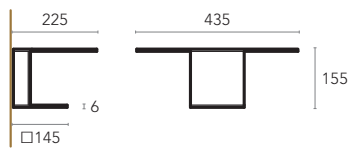

AP-7

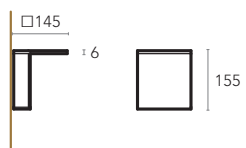

AP-8

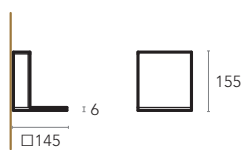

MC

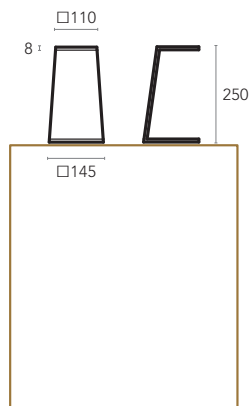

PA-2

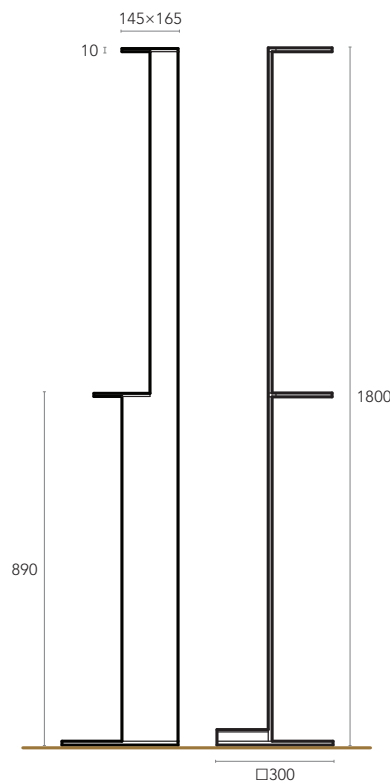

FEATURES

MOUNTING

- Wall
- Table
- Floor

LIGHT SOURCE

- LED
- 3000K, 4000K
- AP-5 – 28W
- AP-7 – 14W
- AP-8 – 14W
- MC – 6W
- PA-2 – 28W

MATERIALS & FINISHING

- ALUMINIUM BODY
- Matt White

MOQ - Minimum Order Quantity

- 10 units



STYLUZ

STYLUZ

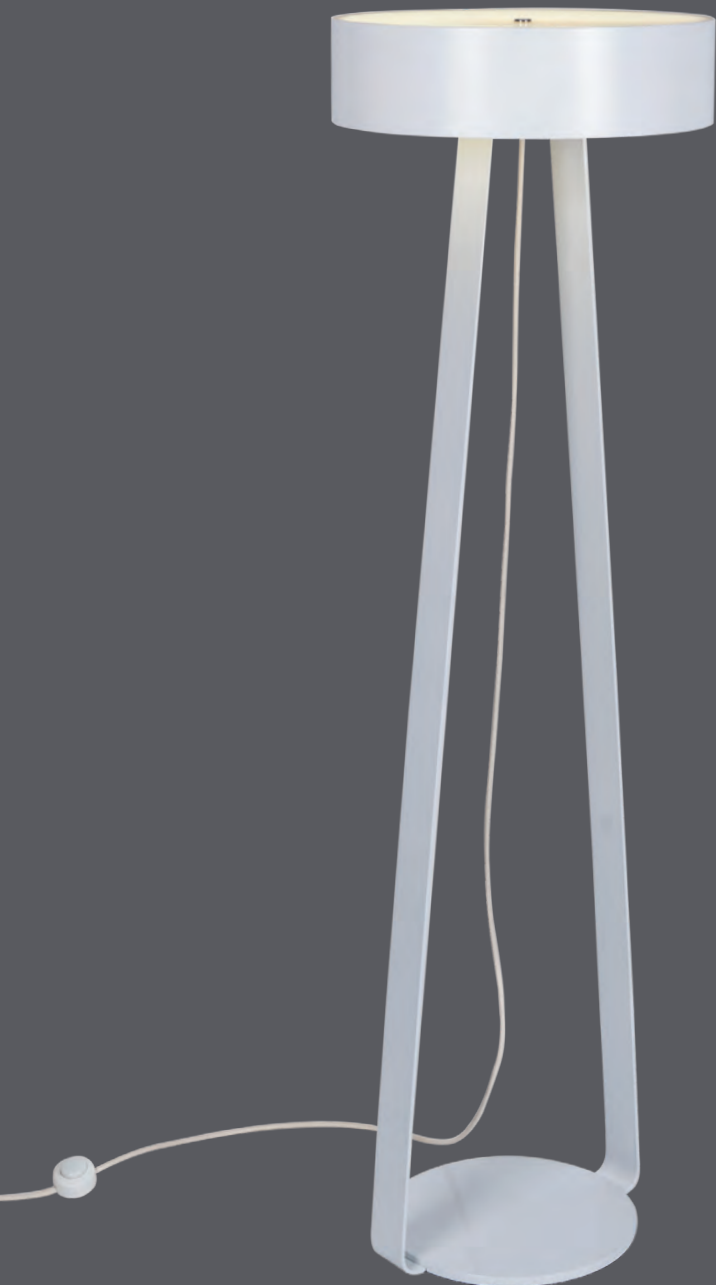

Home with soul, light with style.

Collection of table and floor standing lamps, available in three standard colour sets allowing excellent adaptability to different home and office environments. A sensible combination of noble materials and finishing colours provide the lamps with a luxurious powerful connotation. Nevertheless, keep in mind that this lamp series can be customised to fit your decor needs. The decorative and impressive look of these lamps is coupled with the latest LED technology, guaranteeing energy-efficient implementation of all concepts.





FEATURES

MOUNTING

Table
Floor

LIGHT SOURCE

LED
3000K, 4000K
Table – 17W
Floor – 17W

MATERIALS & FINISHING

STRUCTURE

Matt White, Matt Black

LAMPSHADE

Matt White, Matt Black

MOQ - Minimum Order Quantity

10 units

TABLE

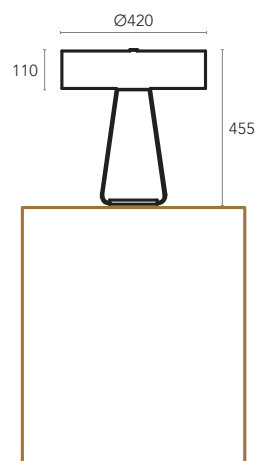

FLOOR

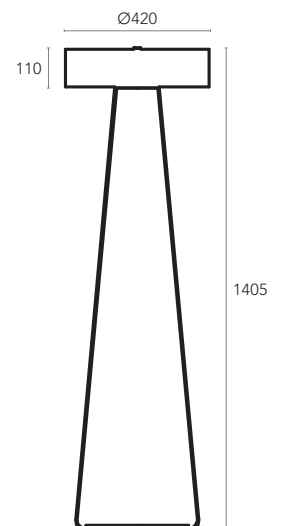

TR3

Elegant structure, glamorous light.

Modern and harmonious lamp series easily recognizable by a structure made of three thin tubes, seductively complemented by a silk lampshade. It is available in a wide range of standard finishes, that can be customised to add a more personalised and welcoming atmosphere to your interior design. The table lamp lampshade is topped by an opal acrylic, allowing for a greater visual comfort to the user. TR3 lamp series is available in floor, table and ceiling lamp versions, enabling comprehensive lighting design in any modern style home decor.

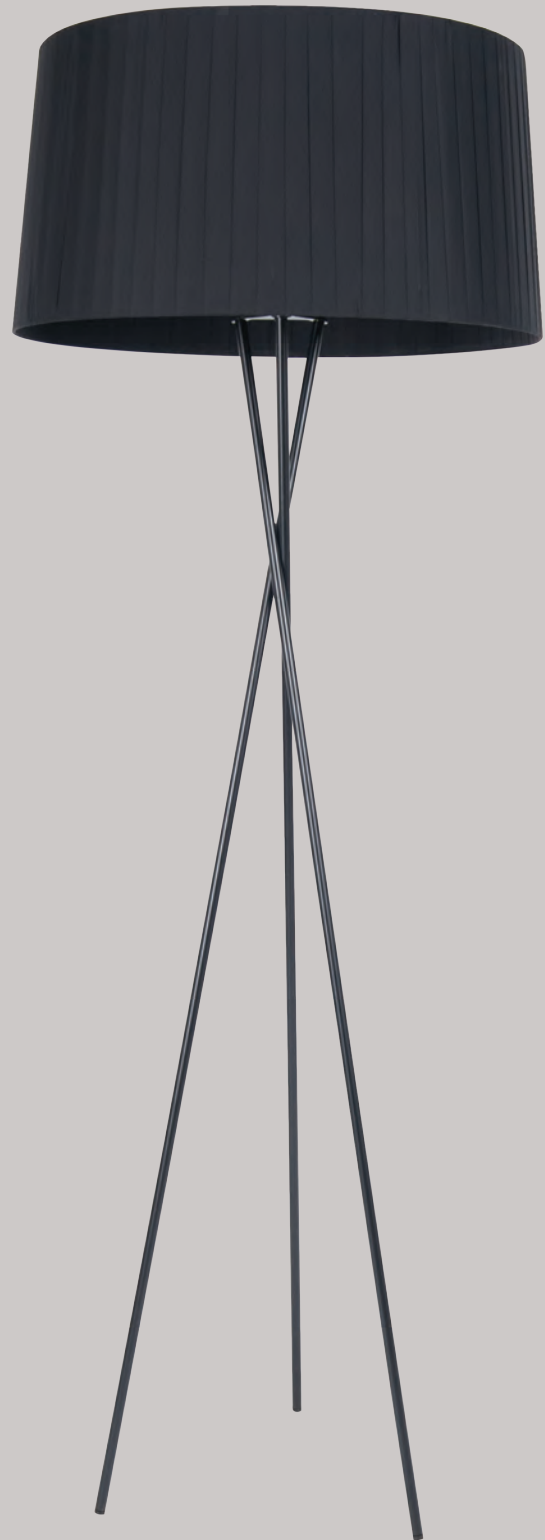



TR3

TR3





FEATURES

MOUNTING

Suspended
Bedside
Table
Floor

LIGHT SOURCE

E27
1× MAX 60W

MATERIALS & FINISHING

STEEL STRUCTURE
Matt White, Matt Black

BRASS STRUCTURE
Brushed Brass

LAMPSHADE
White, Black, Red Pongé Silk

MOQ - Minimum Order Quantity
10 units

SUSPENDED

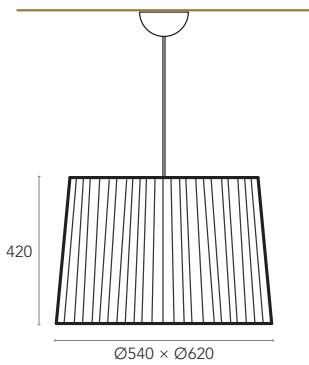

BEDSIDE

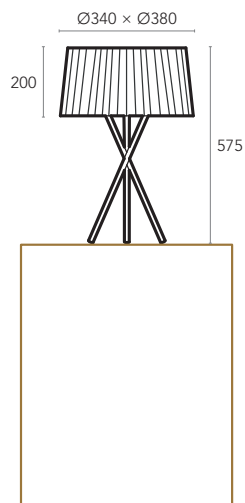

TABLE

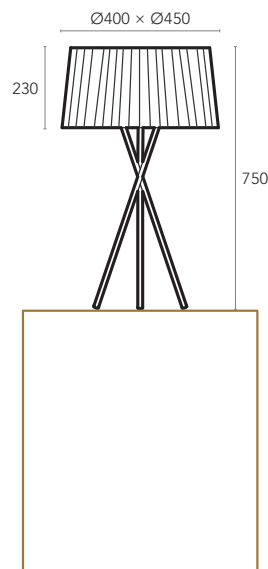

FLOOR

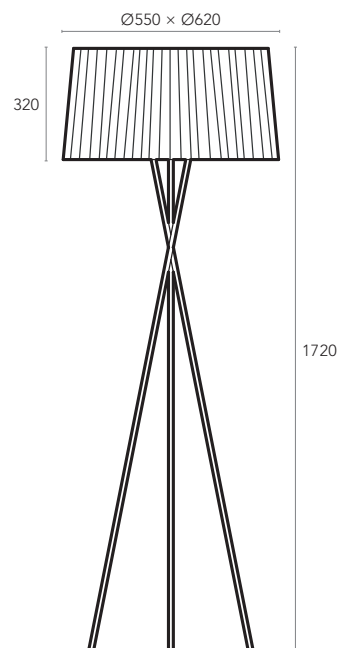



KRIZ



FEATURES

MOUNTING

Table
Floor

LIGHT SOURCE

E27
Table – 1x MAX 60W
Floor – 1x MAX 60W

MATERIALS & FINISHING

ALUMINIUM BODY

Gold Painting

LAMPSHADE

Beige Pongé Silk Fabric

MOQ - Minimum Order Quantity
20 units

TABLE

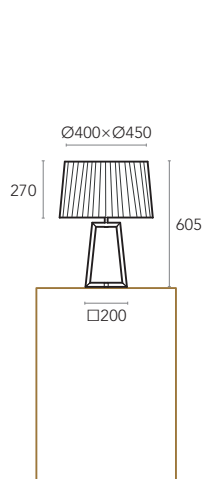

FLOOR

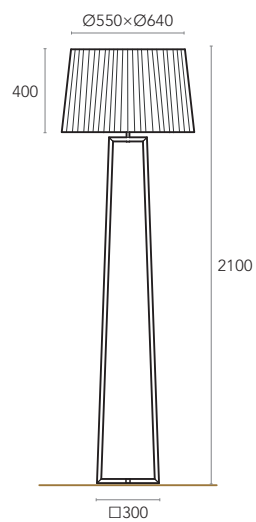

KRIZ



The frames of minimal light.

Modern lamp series with table and floor standing lamp versions. The structure is handmade in aluminium covered by a gold finish, while the lampshade of generous dimensions is in silk. KRIZ family can be customised upon request, adding a more personalised atmosphere to your interior design. It best fits more minimalist environments or hospitality projects.

ARCH

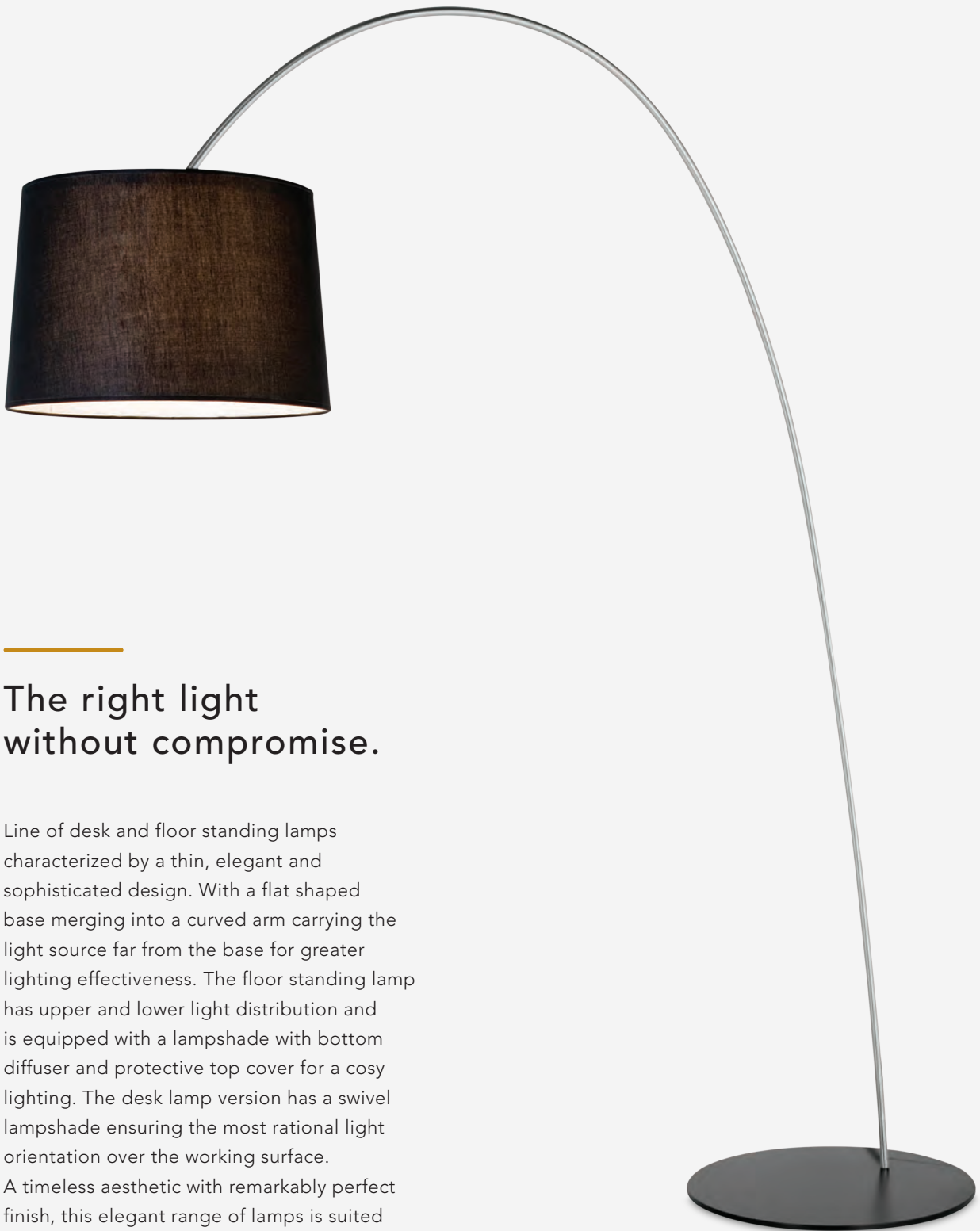

ARCH

The right light without compromise.

Line of desk and floor standing lamps characterized by a thin, elegant and sophisticated design. With a flat shaped base merging into a curved arm carrying the light source far from the base for greater lighting effectiveness. The floor standing lamp has upper and lower light distribution and is equipped with a lampshade with bottom diffuser and protective top cover for a cosy lighting. The desk lamp version has a swivel lampshade ensuring the most rational light orientation over the working surface. A timeless aesthetic with remarkably perfect finish, this elegant range of lamps is suited for home and office environments.



FEATURES

MOUNTING

Table
Floor

LIGHT SOURCE

TABLE
GX53
1× MAX 40W

FLOOR
E27
1× MAX 60W

MATERIALS & FINISHING

TABLE/FLOOR STEEL BODY
Matt White, Matt Black

TABLE LAMPSHADE
White, Black Polypropylene

FLOOR LAMPSHADE
White, Black Piquet Fabric

MOQ - Minimum Order Quantity
30 units

ARCH

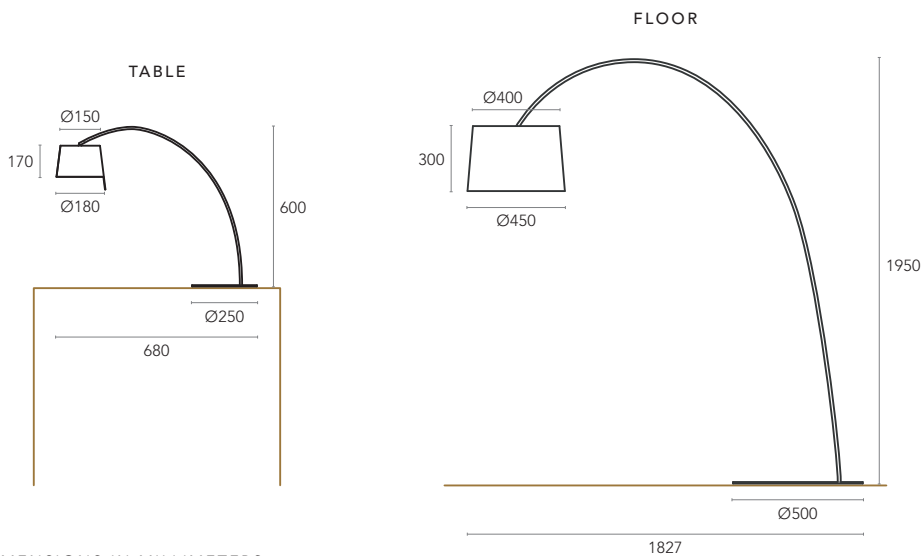

ALL DIMENSIONS IN MILLIMETERS



FEATURES

MOUNTING

Table
Floor

LIGHT SOURCE

E27
Table – 1x MAX 60W
Floor – 1x MAX 60W

MATERIALS & FINISHING

BODY
Brushed Stainless Steel

LAMPSHADE
White, Black Schintz

MOQ - Minimum Order Quantity
50 units

TABLE

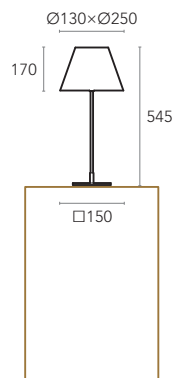

FLOOR

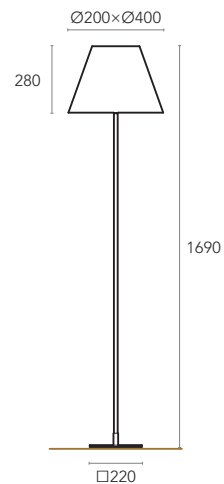

SPAZZO

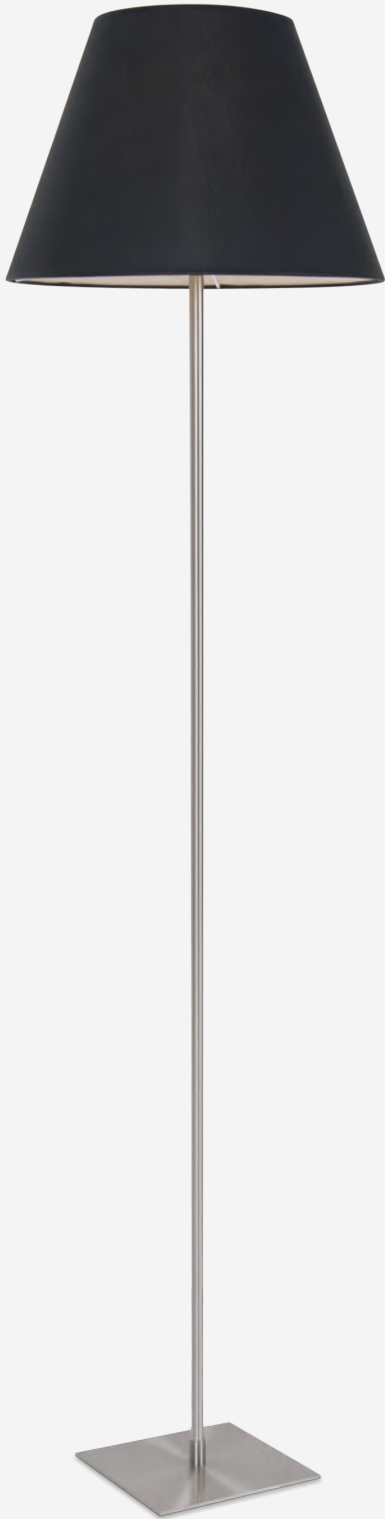

The basics of contemporary.

A collection of table and floor standing lamps with clean lines and fine details. Its brushed stainless steel structure is perfectly complemented by the black or white schintz lampshade. Both these features can be customised upon request to fit your interior design concept. This minimalist design lighting is ideal for a variety of home decor styles.

VERSITY

VERSITY

Unobtrusive forms, timeless design.

Line of table and floor standing lamps with a minimalist style to suit any contemporary environment. The standard lampshades available combine harmoniously with the structure's brushed stainless steel and can be customised by request to include different fabrics and any other colour of your choosing. VERSITY has upper and lower light distribution which offer a soft lighting, attributing simultaneously a cosy and intimate ambience to any setting. These modern lamps will add a contemporary style to any project.

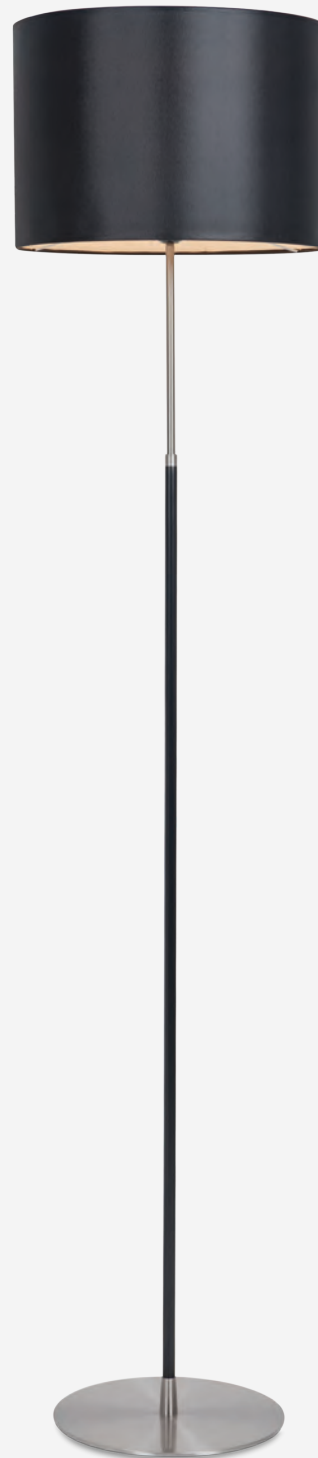



FEATURES

MOUNTING

Table
Floor

LIGHT SOURCE

E27
Table – 1× MAX 60W
Floor – 1× MAX 60W

MATERIALS & FINISHING

BODY
Matt Brushed Stainless Steel

LAMPSHADE

Beige Scal, Red Perc,
Black Schintz

MOQ - Minimum Order Quantity
50 units

ALL DIMENSIONS IN MILLIMETERS

TABLE

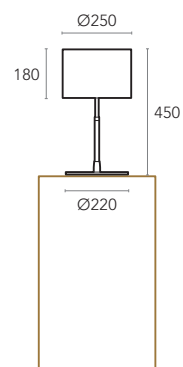

FLOOR

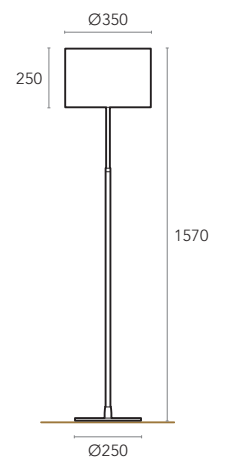

HOSPITALITY 095



FEATURES

MOUNTING

Table
Floor

LIGHT SOURCE

E27
Table – 1× MAX 60W
Floor – 1× MAX 60W

MATERIALS & FINISHING

BODY
Chrome

LAMPSHADE
Glasgow Raw Fabric

MOQ - Minimum Order Quantity
50 units

TABLE

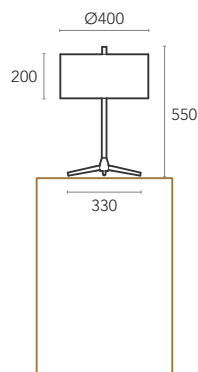

FLOOR

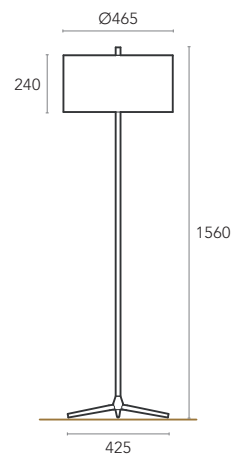

CIVETTA



Slim and stylish.

Collection of table and floor standing lamps with clean and balanced lines. Simple and sober but effective timeless design with a chromed slim structure. Lampshade offering upper and lower light distribution, fitted with a protective top cover providing cosy lighting and remarkably perfect finish. The lampshade can be customised by request to include different fabrics and other colours to fit your interior design concept. CIVETTA lamp series is ideal for a variety of home and hotel decor styles.

MELI

MELI

Minimalist shapes, clean lines.

Table and floor standing lamps with straight well defined lines to suit any contemporary environment. With a brushed stainless steel structure coordinated with Schintz fabric lampshades available in several standard colours, which can be customised to fit your decor needs. The use of materials such as stainless steel, adds a touch of sophistication and modernity to the final piece.





FEATURES

MOUNTING

Table
Floor

LIGHT SOURCE

E27
Table – 1× MAX 60W
Floor – 1× MAX 60W

MATERIALS & FINISHING

BODY
Matt Brushed Stainless Steel

LAMPSHADE
White, Black, Grey Schintz

MOQ - Minimum Order Quantity
50 units

ALL DIMENSIONS IN MILLIMETERS

TABLE

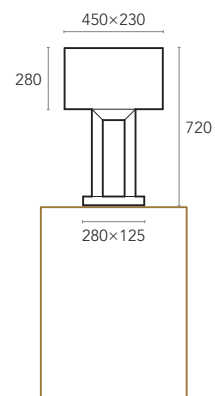

FLOOR

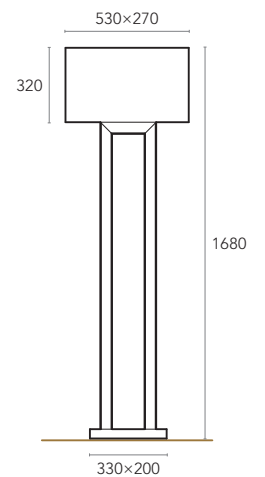



FEATURES

MOUNTING

Table
Floor

LIGHT SOURCE

E27
Table – 1× MAX 60W
Floor – 1× MAX 60W

MATERIALS & FINISHING

BODY
Brushed Stainless Steel

LAMPSHADE
White, Black Schintz
Beige Scala

MOQ - Minimum Order Quantity
50 units

TABLE

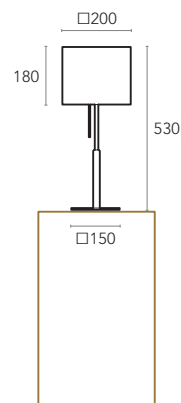

FLOOR

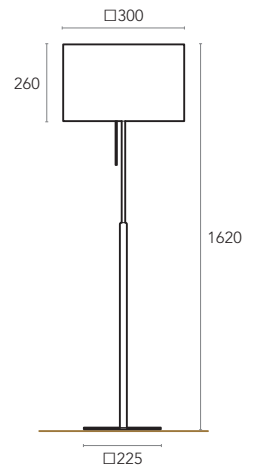

EVA



Linear shapes, welcoming aesthetics.

The EVA line surprises with its forms. It is based on a strong and elegant stainless steel flat structure. The choice of lampshades available help to balance the light, creating an intimate and cosy atmosphere. Its steel structure is pleasant to the touch and eases its framing in any decor. In addition to the standard fabrics available, EVA can be customised upon request to suit your needs.

GRATIA

GRATIA



Classic, timeless characteristics.

Line of floor, table and pendant lamps with a classic style to suit any contemporary environment. With a brushed stainless steel structure and a Rafi 002 (Raffia) lampshade providing both mild and abundant light diffusion, this classic lighting design adds the final touch to any modern style home decor. Table and floor standing versions with pendant switch conveniently located below the lampshade for a quick and easy use.



FEATURES

MOUNTING

Suspended
Table
Floor

LIGHT SOURCE

E27
Suspended – 1× MAX 60W
Table – 1× MAX 60W
Floor – 1× MAX 60W

MATERIALS & FINISHING

BODY
Brushed Stainless Steel

LAMPSHADE
Rafi Fabric

SUSPENDED CEILING CUP
Matt White

MOQ - Minimum Order Quantity
50 units

GRATIA

SUSPENDED

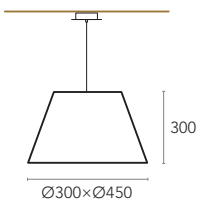

TABLE

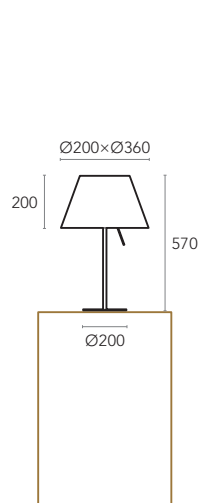

FLOOR

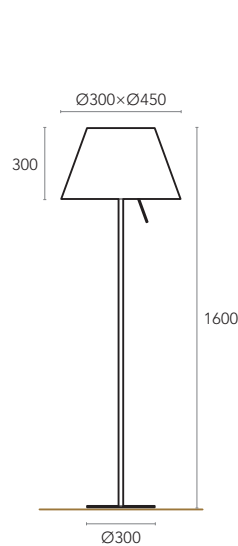



FEATURES

MOUNTING

Table
Floor

LIGHT SOURCE

E27
Table – 1× MAX 60W
Floor – 1× MAX 60W

MATERIALS & FINISHING

BODY

Brushed Stainless Steel

LAMPSHADE

Brown, Beige Versalhe
Brown Suedine

WOOD TUBE

Wengue Wood

STAINLESS STEEL TUBE

Brown Leather Lining

MOQ - Minimum Order Quantity
50 units

NATUR

TABLE

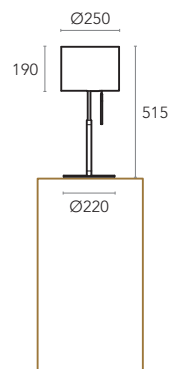

FLOOR

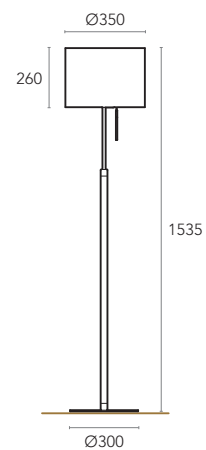

NATUR



Unique details, unusual sights.

Line of table and floor standing lamps, with tube partially covered with wood or synthetic leather and base of brushed stainless steel. The lampshade with its unique patterns, gives NATUR its unmistakable identity and will transmit a sense of elegance and sophistication in every single space.

The pendant switch is conveniently located below the lampshade for a quick and easy use.

Has upper and lower light distribution which offer a soft lighting, attributing simultaneously a cosy and intimate ambiance to any home decor setting.

CHERRY



CHERRY

Geometric lines and mixed materials.

Simple and sober but effective timeless design. Family of wall and table lamps with clean lines and very unique details. The lampshade fabrics combined with the metallic structure and wood inserts provides a design harmonisation between classic visual appeal and modernity. The lampshades can be customised by request to include different fabrics and other colours to fit your interior design concept. CHERRY lamp series is ideal for the home and hotel environment.



FEATURES

MOUNTING

Wall
Table

LIGHT SOURCE

E27
Wall – 1× MAX 60W
Table – 1× MAX 60W

MATERIALS & FINISHING

BODY
Brushed Stainless Steel

LAMPSHADE
White, Black Schintz
Red Perc

WOOD TUBE
Wengue, Cherry, Oak

MOQ - Minimum Order Quantity
50 units

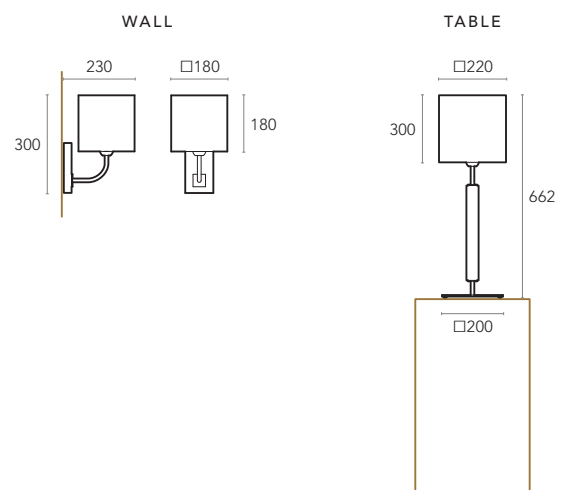



FEATURES

MOUNTING
Suspended
Wall

LIGHT SOURCE
E27
Suspended – 1× MAX 60W
Wall – 1× MAX 60W

MATERIALS & FINISHING
LAMPSHADE
White, Red, Black,
or Beige Pongé Silk

DIFFUSER
PVC Natur

MOQ - Minimum Order Quantity
30 units

SUSPENDED

WALL

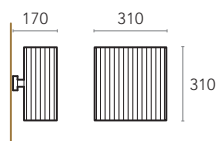
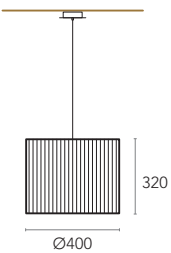

MUSE



Silk touches, smooth ambiance.

In pendant and wall mounted versions, MUSE is known for its simplicity and refinement. The smooth silk lampshade lends an elegant and sophisticated touch to the lamp, while the bottom diffuser provides the perfect lighting to the whole surrounding area. In addition to the wide range of standard colours available, MUSE can be customised with any other colour for a more personalised and welcoming atmosphere. These modern, timeless design lamps will add a contemporary style to any interior design project.

FLEX



FLEX

The effective simplicity, as usual.

Series of wall mounted lamps able to create intimate and cosy environments. FLEX wall lamp is a geometric versatile piece, which can be used in almost any room. The lightness and resistance of the lampshade makes it remarkably long-lasting, completely concealing the wall base structure. It is available in three sizes with lampshade in a careful selection of standard fabrics and colours. Both these features can be customised upon request for a more personalised and welcoming atmosphere. Ideal solution for a variety of home and hotel decor styles.



FLEX

FEATURES

MOUNTING

Wall

LIGHT SOURCE

E27

Small – 1× MAX 60W

Medium – 1× MAX 60W

Large – 1× MAX 60W

MATERIALS & FINISHING

LAMPSHADE

White, Orange, Blue,
Red, Green Perc

MOQ - Minimum Order Quantity

50 units

SMALL

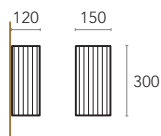

MEDIUM

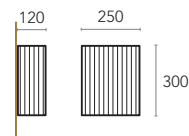

LARGE

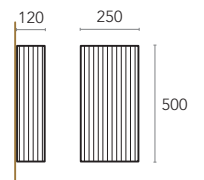



WALL

STONE



DESIGN BY ALBINO MIRANDA

Design configurations only limited by imagination.

This lighting design celebrates the inexplicable and inherent beauty of river rocks – seemingly simple, the complexity of their form and how they interact are the result of thousands of years of sculpting by nature – STONE series captivates imagination while providing a warm and inviting tone to any room. Always in combination of large and small sizes, resulting in unique design configurations further enhanced by a carefully engineered LED board designed specifically for this model. STONE is available in four sizes, two wall clearances and several standard colours that can be customised according to your needs and requests.



STONE

FEATURES

MOUNTING

Wall

LIGHT SOURCE

LED
3000K, 4000K – 2W
RGBW – 6W

MATERIALS & FINISHING

ALUMINIUM BASE

Matt White

FIBERGLASS COVER

Matt White

Gold

Other colours on request.

MOQ - Minimum Order Quantity

10 units

BASES

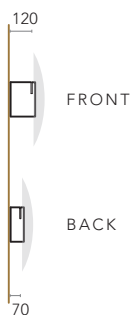

COVERS

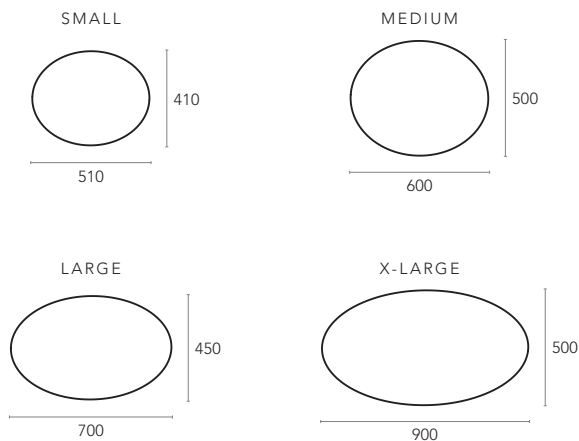



FEATURES

MOUNTING
Wall

LIGHT SOURCE
LED
3000K, 4000K – 2W
RGBW – 6W

MATERIALS & FINISHING

ALUMINIUM BASE
Matt White

FIBERGLASS COVERS
Matt White
Other colours on request.

MOQ - Minimum Order Quantity
10 units

BASE

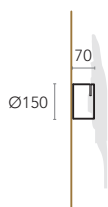

COVERS

SMALL

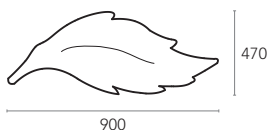

MEDIUM

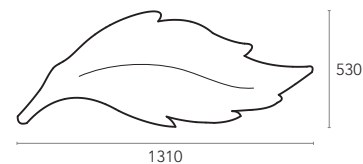

LARGE

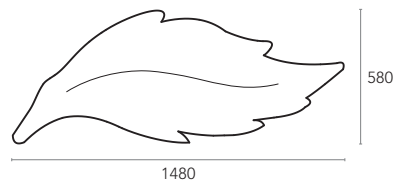

LEAF



DESIGN BY ALBINO MIRANDA

Walls are surfaces of creativity.

LEAF wall mounted luminaire arises as a new idea for the lighting and decoration of interior spaces, based on an expressive design inspired by nature. This lighting design was born from the desire to create a delightful luminaire while achieving excellent diffusion and a soft ambient light. With a strong decorative character whether with the light on or off, LEAF compositions are distinctive in any room. It is available in three sizes for absolute creative freedom, with standard finish in white that can be customised to suit your interior design project.

POZI



POZI

Modernism running along the wall.

The POZI is the unique combination of a wall mounted lamp and pendant lamp! It's a beautiful lamp that runs along the wall and stretches its lampshade into the room through an elegant curve and a suspended cable, creating the perfect mood while spreading a soft diffused light. This original light fixture enables you to complete your interior lighting design, giving a stylish, high-quality finish to your home, restaurant or hotel.



FEATURES

MOUNTING
Wall

LIGHT SOURCE
LED
2700K, 3000K, 4000K
5W
External Driver

MATERIALS & FINISHING
ALUMINIUM BODY
Textured Black

DIFFUSER
Opal Glass

MOQ - Minimum Order Quantity
10 units

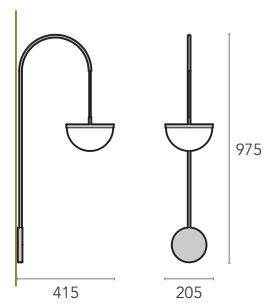



FEATURES

MOUNTING

Wall

LIGHT SOURCE

LED
3000K, 4000K
66W
External Driver

MATERIALS & FINISHING

ALUMINIUM STRUCTURE
Matt White

HIGH DENSITY FOAM
White

MOQ - Minimum Order Quantity
5 units

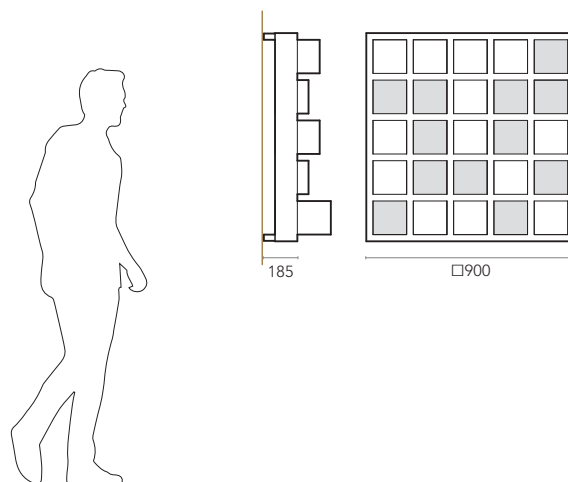

CHESS



The game is on the wall, waiting to be played.

Wall modular lighting system with the ability to be arranged in various configurations, creating distinct and unique designs. It effectively illuminates space whilst bringing light to a new art form. CHESS can be used as a single light source or in groups of several modules for a dramatic effect. This wall modular lighting system uses LED technology and is available in units equipped with high density foam blocks. The ability to "play" with the position of each foam block allows for periodic arrangements and creation of personalised looks.

WAVE



WAVE

Tides of artistic creation.

A new concept for the lighting and decoration of interior spaces, allowing countless composition possibilities based on a clean and simple design. WAVE blends light functionality with an opportunity for artistic creation, an invitation for interior designers to dress walls. This wall modular lighting system uses LED technology and is available in modules, creating stunning light effects when several units are grouped together.



WAVE

FEATURES

MOUNTING
Wall

LIGHT SOURCE
LED
3000K, 4000K
36W

MATERIALS & FINISHING
ALUMINIUM STRUCTURE
Matt White

MOQ - Minimum Order Quantity
5 units

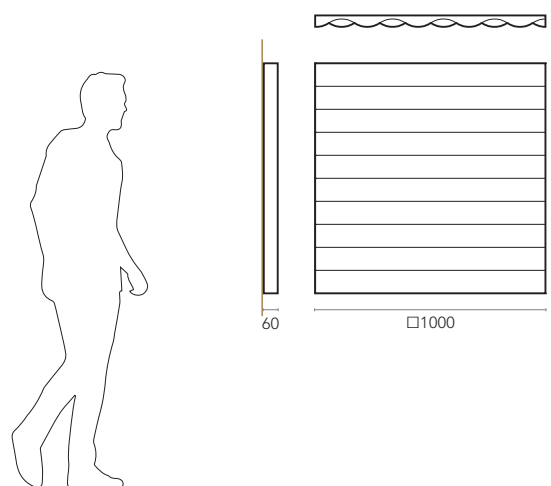



SUSPENDED

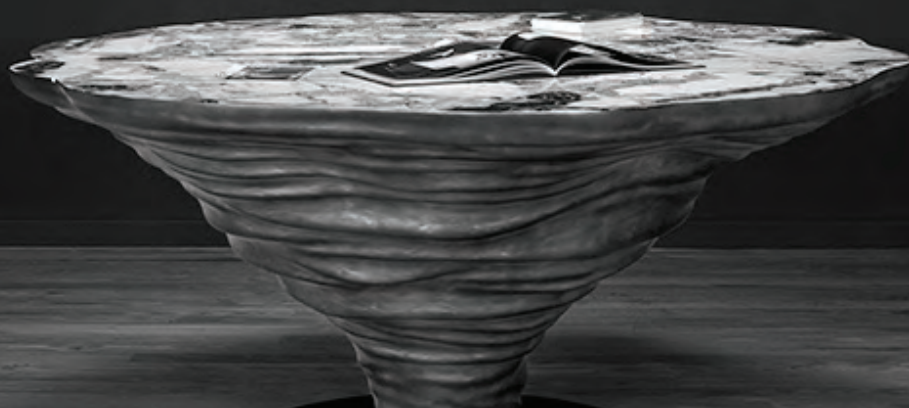
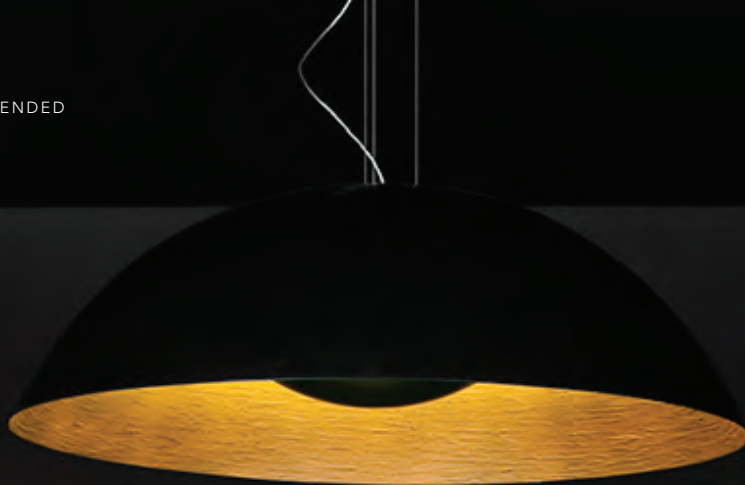

ROCHÉ

FEATURES

MOUNTING
Suspended

LIGHT SOURCE

LED
3000K, 4000K
Ø800 – 50W | Ø1400 – 70W

E27
Ø800 – 6× MAX 60W
Ø1400 – 5× MAX 60W

MATERIALS & FINISHING

FIBERGLASS BODY

INSIDE

Gold Painting

OUTSIDE

Ø800 - Matt White, Matt Black
Ø1400 - Matt Dark Green

MOQ - Minimum Order Quantity
4 units

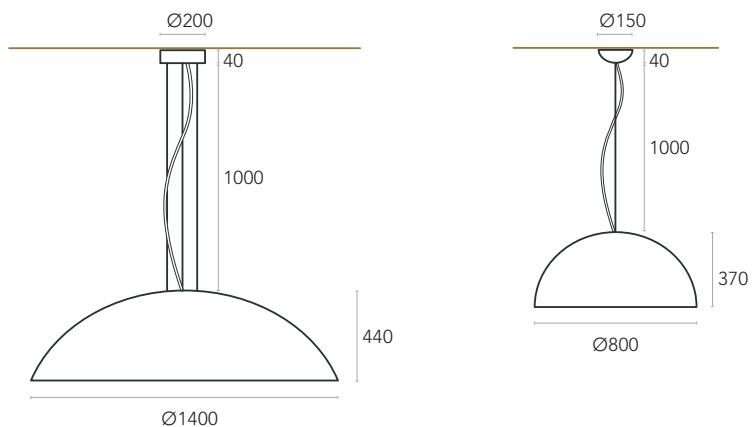



ROCHÉ

DESIGN BY ALBINO MIRANDA

Interior ambience takes on a life of its own.

A large dome shaped suspension available in different colours to create a truly impressive lamp. With the latest in contemporary styling, ROCHÉ pendant features an oversized dome shade, which serves as a dynamic focal point to establish a room's overall look and feel. The ambitious combination of colours creates a truly impressive image while its form creates the illusion that the entire inner surface of the sphere radiates light. With a standard range of finishing colours and cord styles, which can be customised to fit your decor needs, ROCHÉ makes a statement in any space.

FLOWIN

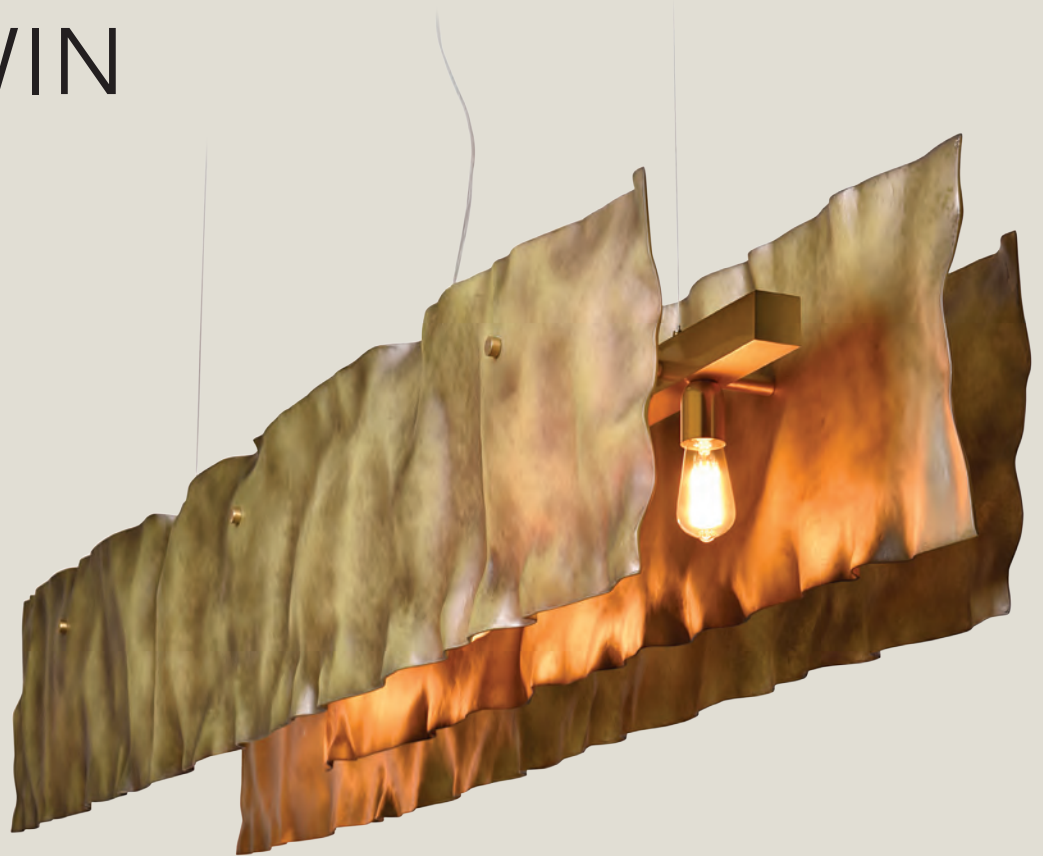

FLOWIN

DESIGN BY ALBINO MIRANDA

Imposing sculptural shapes.

Feel the true statement of luxury with this impressive pendant lamp, suited for the most exquisite rooms. Its composite fibreglass shade is mounted on a polished brass structure and emits a filtered light which creates beautiful atmospheres and shadows. With a high level of craftsmanship, this unique lighting design is entirely shaped and assembled by hand. FLOWIN will truly shine in a classic dining or living room design or you can even place it in the lobby of a hotel.



FLOWIN

FEATURES

MOUNTING
Suspended

LIGHT SOURCE
E27
4x MAX 60W

MATERIALS & FINISHING
STRUCTURE
Brushed Brass
LAMPSHADE
Translucid Fiberglass

MOQ - Minimum Order Quantity
4 units

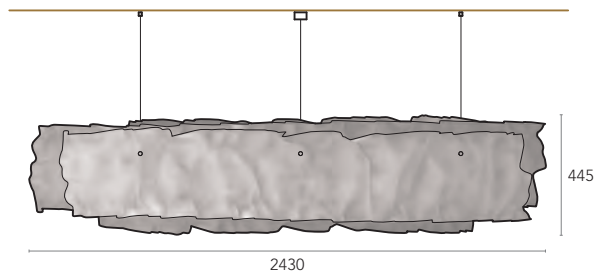
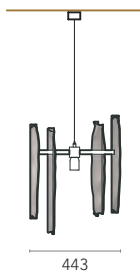

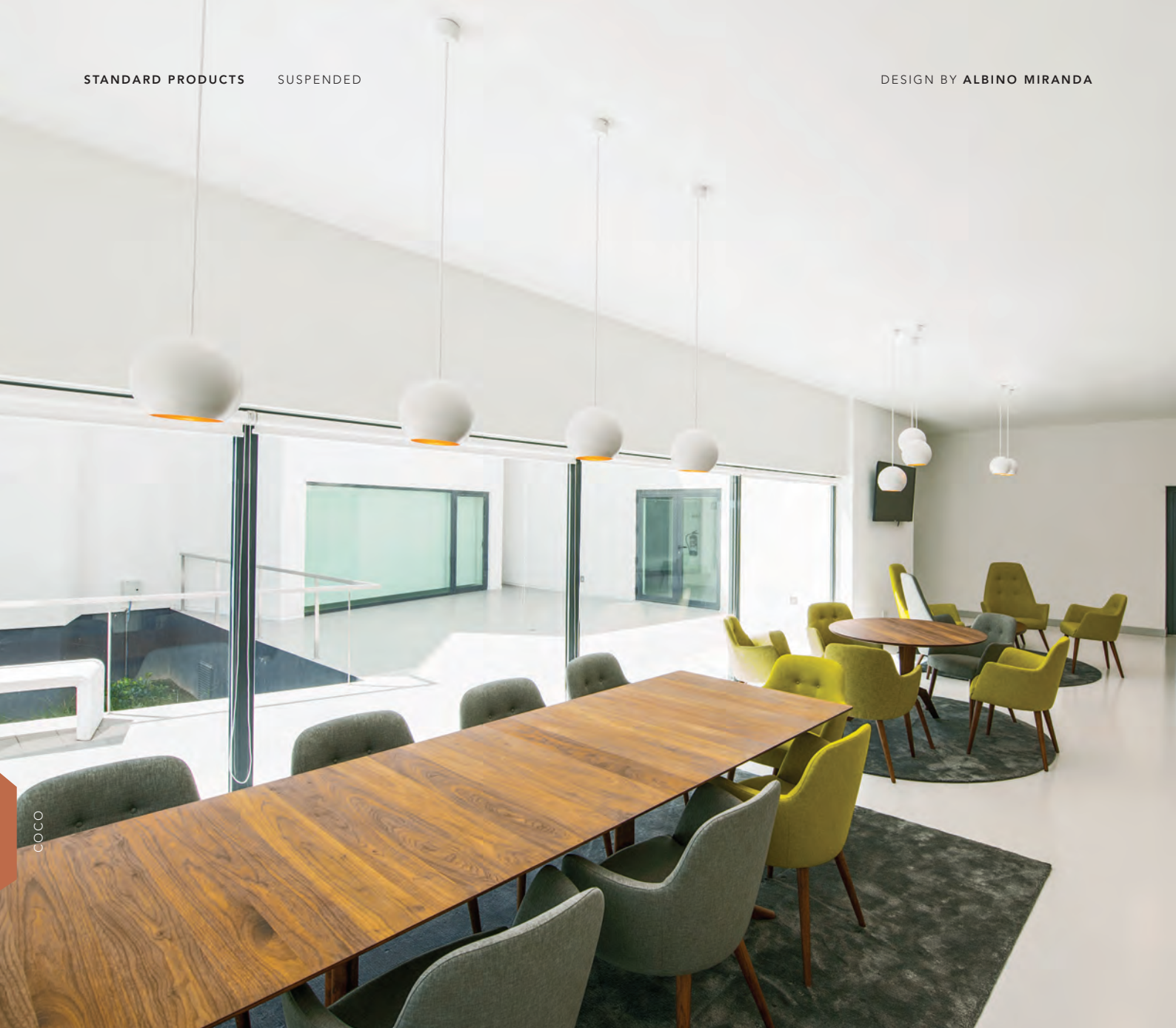

COCO

FEATURES

MOUNTING

Suspended

LIGHT SOURCE

LED
3000K, 4000K
5W, 8W
Recessed - External Driver

MATERIALS & FINISHING

FIBERGLASS BODY

INSIDE

Gold Painting

OUTSIDE

Matt White, Matt Black

FEED CABLE

Matt White, Matt Black

MOQ - Minimum Order Quantity

10 units

SURFACE

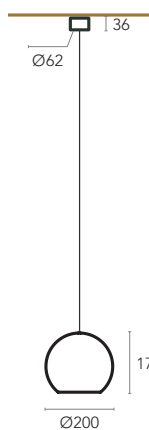

RECESSED

LARGE CEILING CUP



SMALL CEILING CUP

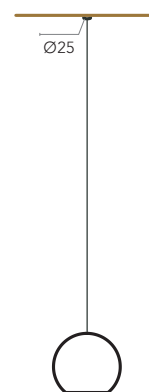

COCO



DESIGN BY ALBINO MIRANDA

Delicate elegance but strong light expression.

COCO pendant lamp gets rid of everything to keep only the essential, with colour taking centre stage. The interior ambience takes on a life of its own with these simple clean shapes and colour contrasts enhanced by LED light sources. When using several lamps to make a composition, the visual effect is just mesmerising. The bicoloured fibreglass body is combined with an unobtrusive suspension of single cable system for a true floating effect. Both these features can be customised to include other finishing colours and different suspension heights. COCO is suitable for integration into any contemporary environment, creating relaxed and warm atmospheres in hotels, restaurants and indoor walkthrough areas.

GRANDI

DESIGN BY MARCO SOUSA SANTOS

Practical simplicity.

An unrivalled example of minimalistic design, GRANDI pendant lamp features clean lines that are a perfect addition to any contemporary room. Pendant lamp composed of an aluminium structure and a polypropylene lampshade available in five versions with different sizes and shapes. The black polypropylene version is white on the inside for a higher reflection coefficient.





GRANDI

FEATURES

MOUNTING

Suspended

LIGHT SOURCE

E27
1x MAX 60W

MATERIALS & FINISHING

STRUCTURE

Matt White, Black

SCREEN

Opal Polycarbonate (Translucent)
White Polypropylene
Black/White Polypropylene

FEED CABLE

Matt White, Matt Black

MOQ - Minimum Order Quantity

20 units

SMALL

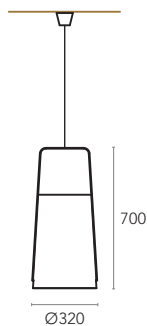

MEDIUM

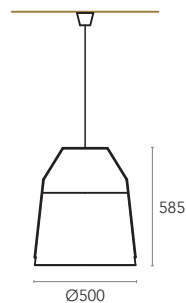

LARGE

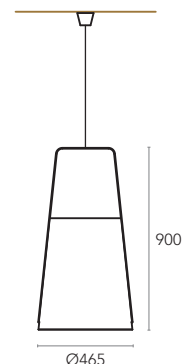



TABRIGA

FEATURES

MOUNTING

Suspended

LIGHT SOURCE

E27
1x MAX 60W

MATERIALS & FINISHING

ALUMINIUM BODY
Textured White, BlackDIFFUSER
Clear or Opal Tempered GlassMOQ - Minimum Order Quantity
20 units



TABRIGA

TABRIGA

Evoked warm and soft atmospheres.

An exercise in contrasts, the TABRIGA pendant fuses the classic and the modern, the maritime and the industrial with simple yet up-to-date shapes. The matt black base combined with a clear glass shade provides a balanced design and wonderful light effects. The set hangs from a high strength chain suspension. Both these features can be customised to include other finishing colours and different suspension heights. TABRIGA is a pendant lamp with clean lines and graceful proportions, enabling comprehensive lighting design for the living and office environment.

RAY



RAY

Contemporary design and clear lines.

This airy pendant lamp is a classic. Its lampshade is handmade in wood by highly skilled craftsmen and is combined with an unobtrusive suspension that can be customised to allow different suspension heights. The wood provides a soft luminosity for atmosphere and appeal, while the delicate shadows it creates are both beautiful and surprising. A magnificent suspension, sophisticated and very functional, that is equally suited to contract and domestic settings.



FEATURES

MOUNTING

Suspended

LIGHT SOURCE

E27
1× MAX 60W

MATERIALS & FINISHING

WOOD STRUCTURE
Betula Plywood

MOQ - Minimum Order Quantity
20 units





FEATURES

MOUNTING

Suspended

LIGHT SOURCE

E27
1× MAX 60W

MATERIALS & FINISHING

LAMP HOLDER

Matt Black
Gold Painting

STEEL WIRING STRUCTURE

Matt Black

MOQ - Minimum Order Quantity

20 units

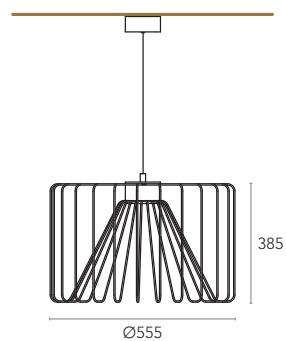

VOID

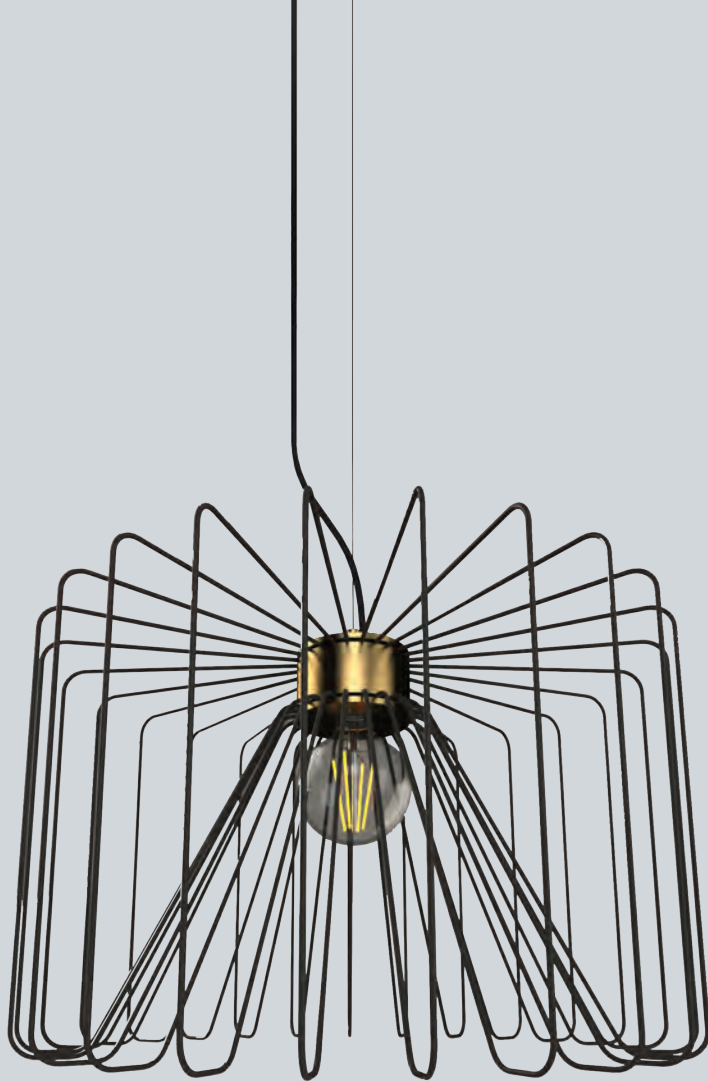

VOID

Turn any space into a unique location.

VOID looks like a sketch drawn in the air, showing an almost transparent design that adds an avant-garde touch to rooms. Its wire structure filters the light, creating a particular lighting effect in the environment. VOID can be hung individually or as a composition for a unique visual effect. Collection of pendant lamps made of shaped and powder coated steel wire. These stylish lamps are available in three shapes featuring a matt black standard finish, which can be customised upon request to fit your interior design concept.

GARLAND



GARLAND

DESIGN BY CARLOS CASTANHEIRA

Floating light shapes.

A unique lighting design, boasting a high level of craftsmanship, light, technology and shape. GARLAND geometric shape and symmetrical balance will bring a cosy feeling of warmth and harmony into any interior design project. The piece's soft aura complements the pool of light that it casts below and the clean, simple style of its design. It is suspended by a triple cable system that can be adjusted for different ceiling heights. The homogeneous light distribution will make this unique lighting design suitable to be used in any modern style decor in residential and public environments.



GARLAND

FEATURES

MOUNTING

Suspended

LIGHT SOURCE

LED
3000K, 4000K

AMBIENT LIGHT

Small – 35W
Large – 70W

DIRECT LIGHT

Beam Angles 12°, 24°, 36°
13W

MATERIALS & FINISHING

ALUMINIUM BODY / CEILING CUP
Matt Grey

DIFFUSER

Opal Polyethylene

OPTION

Suspension height on request.

ALL DIMENSIONS IN MILLIMETERS

ARRANGEMENTS

Ambient
Light

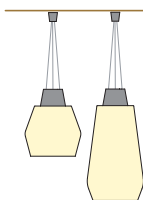

Ambient and
Direct Light



SMALL

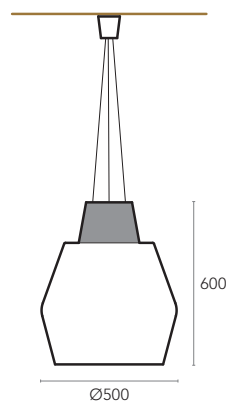

LARGE

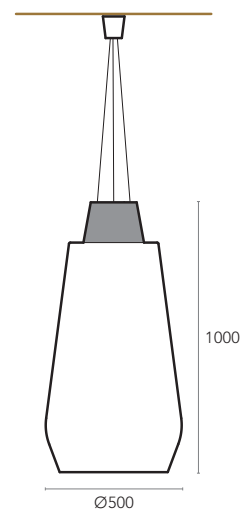



SPELL

FEATURES

MOUNTING
Suspended

LIGHT SOURCE
E27
1× MAX 60W

MATERIALS & FINISHING

ALUMINIUM BODY

OUTSIDE	INSIDE
Matt White	Matt White
Matt Black	Matt White
Gold Painting	Gold Painting

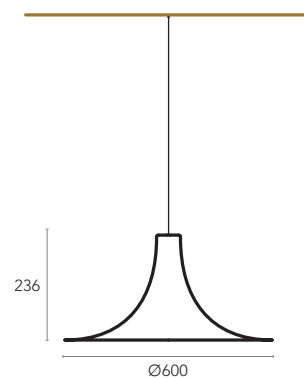

SPELL



A new take on a classic.

SPELL pendant lamp combines the iconic design with contemporary interior trends. Characterised by clean geometric lines, SPELL expresses its strong personality with an unusual collection of colour combinations which can be customised in multiple other finishes. Due to the light source prominence, we recommend the use of LED filament bulbs which match perfectly with the lamp style and accentuate its character.

EDGY



EDGY

Urban and minimalistic lifestyle decor.

The EDGY pendant lamp is a recreation of the type of lamp used for generations in public areas, workshops and private homes. Featuring a solid and industrial look that perfectly suits contemporary interior design concepts, it is available in several colour alternatives, which can be customised in multiple other finishes. Its lacquered metal lampshade disperses the light in a subtle but spectacular way and will look great when lit with a warm bulb for a softer and inviting illumination. A sophisticated addition to any interior.



EDGY

FEATURES

MOUNTING
Suspended

LIGHT SOURCE
E27
1 × MAX 60W

MATERIALS & FINISHING

ALUMINIUM BODY

OUTSIDE	INSIDE
Matt White	Matt White
Matt Black	Matt White
Gold Painting	Gold Painting

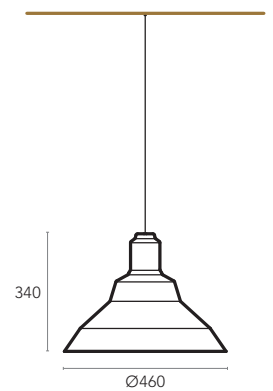



FEATURES

MOUNTING
Suspended

LIGHT SOURCE
E27
1× MAX 60W

MATERIALS & FINISHING

ALUMINIUM BODY

OUTSIDE	INSIDE
Matt White	Matt White
Matt Black	Matt White
Gold Painting	Gold Painting

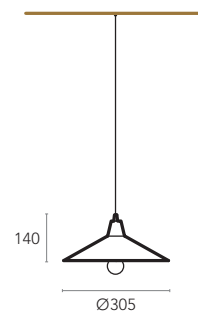

CONE

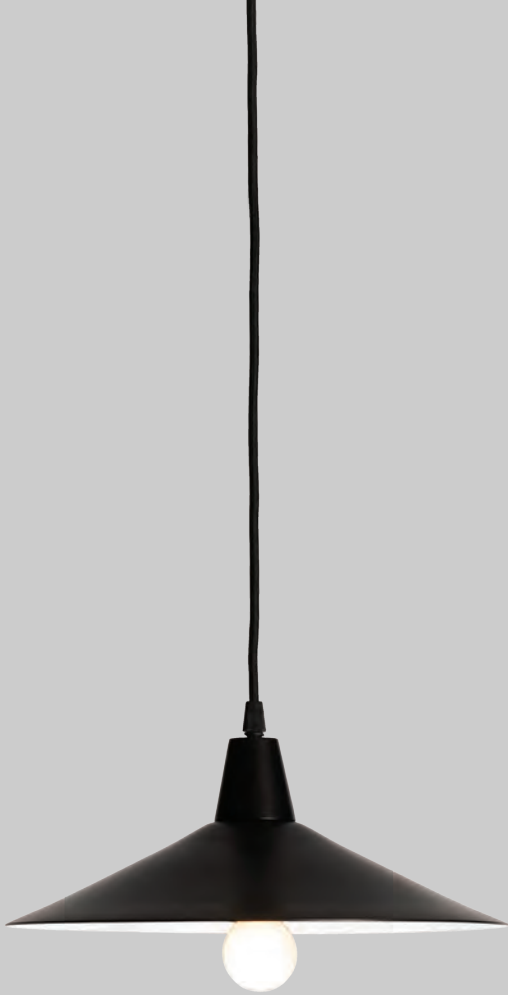

Light pared down to its essential elements.

CONE is an elegant pendant light that retains the essence of a traditional pendant light fitting while still being wholly contemporary. Featuring a minimalist design that perfectly suits trendy interior design concepts, it is available in several colour alternatives, which can be customised in multiple other finishes. Due to the light source prominence, we recommend the use of rustic style LED bulbs that perfectly match the look of the lamp and accentuate its nostalgic character.

TORCH



TORCH

Rustic elegance in style and finish.

TORCH circular chandelier is a simple lighting design with a lot of character. It's styled with an imposing ring accented with candelabra sockets to give the fixture a medieval vibe. The TORCH chandelier features a matt black standard finish which can be customised upon request to fit your interior design concept. This chandelier is ideal for bringing outstanding illumination to a dining room table, formal sitting area or any other space that needs to be enhanced with a captivating lighting piece.



FEATURES

MOUNTING
Suspended

LIGHT SOURCE
E14
Ø800 – 8× MAX 60W
Ø1000 – 10× MAX 60W
Ø1200 – 12× MAX 60W
Ø1400 – 14× MAX 60W
Ø1800 – 18× MAX 60W

MATERIALS & FINISHING
ALUMINIUM STRUCTURE
Textured Black

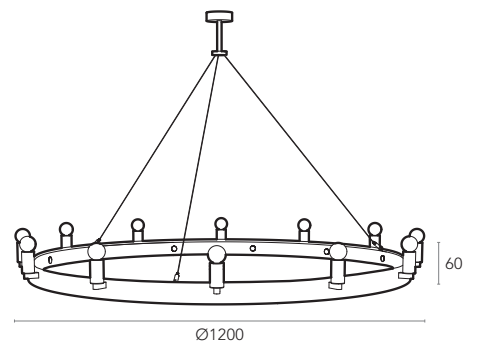



FEATURES

MOUNTING
Suspended

LIGHT SOURCE
G4
6× MAX 20W

MATERIALS & FINISHING

ALUMINIUM STRUCTURE
Glossy White

DIFFUSER TUBES
Inside: Opal Tempered Glass
Outside: Clear Tempered Glass

MOQ - Minimum Order Quantity
10 units

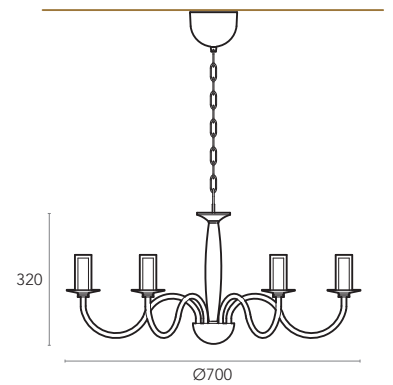

FIORI



The classic chandelier.

Irregular hexagonally shaped pendant lamp, marked by asymmetrical sharp edges. Bicoloured finished (matt white and black) aluminium housing luminaire. Characterized by a high luminous efficiency achieved with the use of LED and the homogeneous diffusion in both directions (direct and indirect light). Luminaires appealing design blends with the LED technology reliability and high energy efficiency. Opal polycarbonate diffuser ensuring glare control.

GALERIA

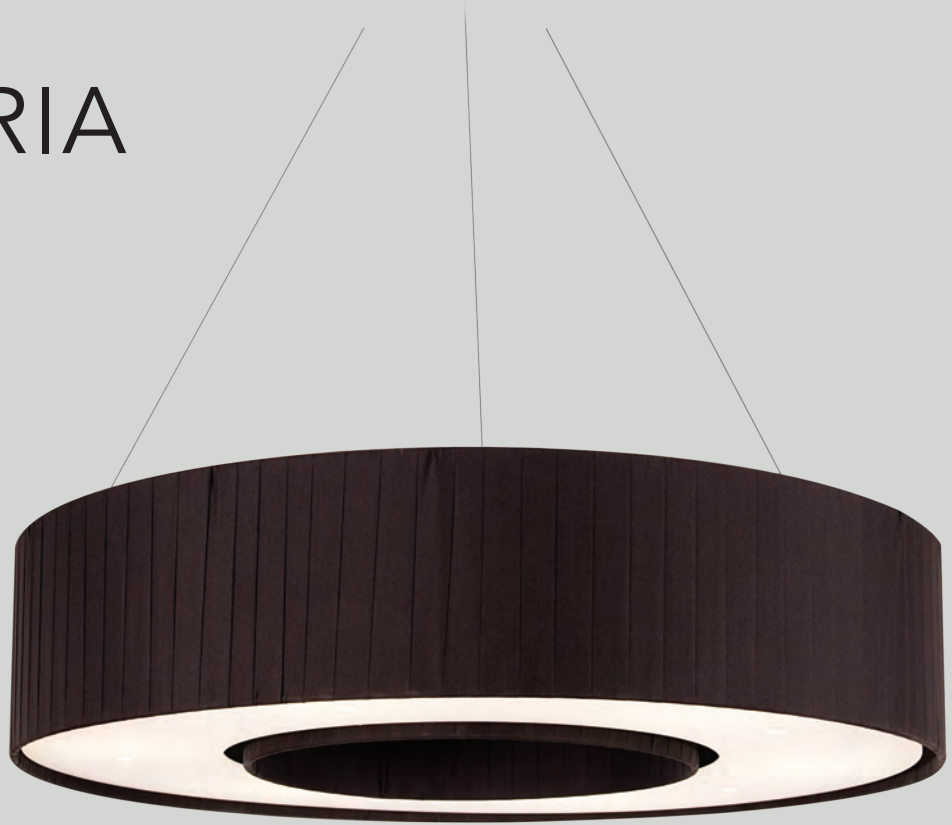

GALERIA

Lighting enchantment.

Simple yet eye-catching pendant lamp that brings you a timeless design. The soft touch of the silk lining complements the uniform lighting that casts from its bottom diffuser, bringing a cosy feeling of warmth and harmony into any interior design project. The standard colours available can be customised by request to include different fabrics and colours to fit your decor needs. GALERIA is suspended by a triple cable system that can be adjusted for different ceiling heights. This pendant lamp is ideal for bringing outstanding illumination to a dining room, a formal sitting area or any other space that needs to be enhanced with a captivating lighting piece.



FEATURES

MOUNTING
Suspended

LIGHT SOURCE
E27
Ø800 – 6× MAX 60W
Ø1000 – 8× MAX 60W
Ø1200 – 16× MAX 60W

MATERIALS & FINISHING

LAMPSHADE
Red, Black, Beige
or Dark Beige Pongé Silk

DIFFUSER
PMMA Opal

MOQ - Minimum Order Quantity
20 units

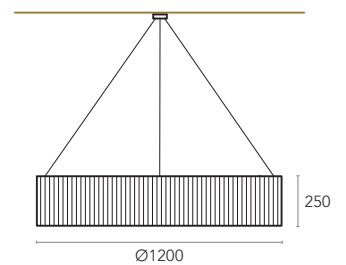
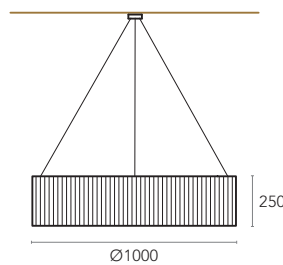
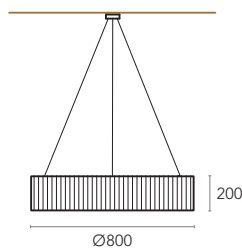

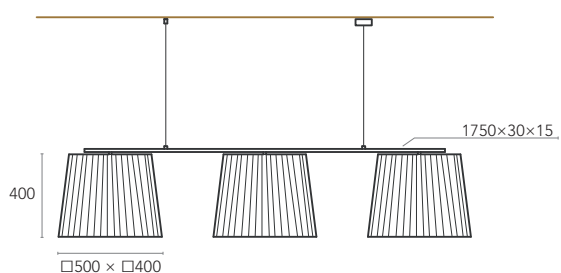

FEATURES

MOUNTING
Suspended

LIGHT SOURCE
E27
3× MAX 60W

MATERIALS & FINISHING
LAMP SHADE
Red, Black, Beige
or Dark Beige Pongé Silk
DIFFUSER
PVC Natur

MOQ - Minimum Order Quantity
20 units

MEET



Classic personality for welcoming atmospheres.

Pendant lamp featuring a voluminous lampshade in close dialogue with an upper structure to inject personality into a space. The lampshade guarantees max use of the light source, while offering upper and lower light distribution. It is finished with a bottom diffuser providing cosy lighting and remarkably perfect finish. In addition to the range of standard colours available, it can be customised by request to include different fabrics and other colours to fit your interior design concept. This voluminous pendant lamp is ideal for the home and hotel environment.

ECO



ECO

Perfect balance of the traditional.

Harmonious pendant lamp series easily recognizable by a smooth silk lampshade, seductively complemented by a slender tube structure. The lampshade classic appeal lends an elegant and sophisticated touch to the lamp, while the bottom diffuser provides the perfect lighting to the whole surrounding area. In addition to the standard colours and metallic finishes available, both these features can be customised for a more personalised and welcoming atmosphere. A timeless aesthetic with remarkably perfect finish, suitable to be used in a modern living room design or as a modern dining room lighting.



ECO

FEATURES

MOUNTING

Suspended

LIGHT SOURCE

E27
 Single – 1x MAX 60W
 Double – 2x MAX 60W

MATERIALS & FINISHING

STEEL STRUCTURE
 Matt White, Matt Black,
 or Matt Grey

LAMPSHADE
 Red, Black, Beige
 or Dark Beige Pongé Silk

DIFFUSER
 PMMA Opal

MOQ - Minimum Order Quantity
 20 units

SINGLE

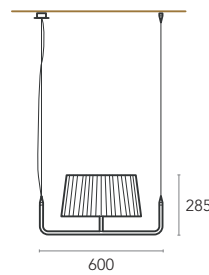

DOUBLE

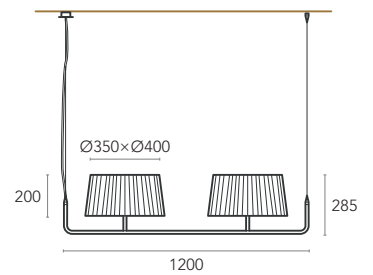



FLOOR

SCAPES

DESIGN BY **MODO ASSOCIADOS**

High-quality lighting for stylish rooms.

Stark and elegant, the SCAPES floor stands upright, balancing on a flat base creating the illusion of floating. The sleek profile lamp uniformly emits a wide vertical beam of light through a specially developed Polycarbonate diffuser designed to soften LED light while maximizing output. It is available in two heights and black textured standard color, which can be customised in multiple other finishes. It is a sophisticated and very functional floor standing lamp that integrates brilliantly into a wide variety of room and lighting concepts in the private and commercial sectors.

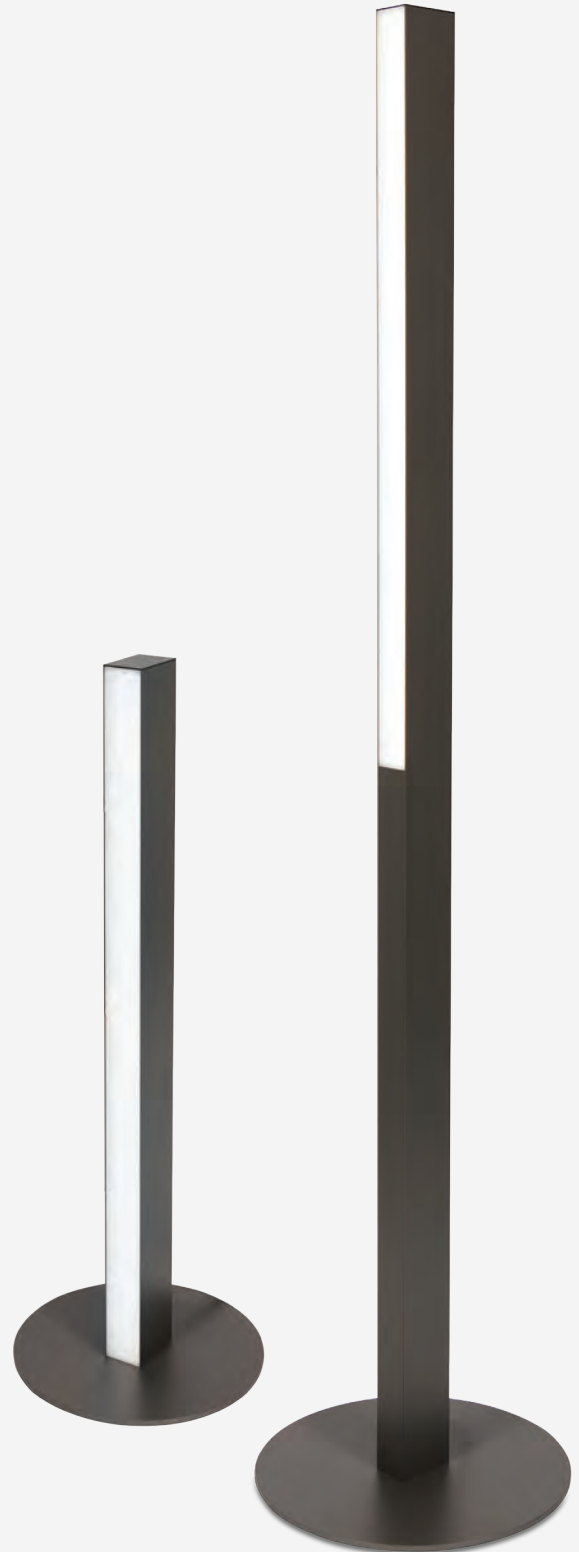



SCAPES

FEATURES

MOUNTING

Floor

LIGHT SOURCE

LED
3000K, 4000K
Tall – 20W
Short – 20W

MATERIALS & FINISHING

ALUMINIUM BODY
Textured Black

DIFFUSER

Opal Polycarbonate

MOQ - Minimum Order Quantity

6 units

ALL DIMENSIONS IN MILLIMETERS

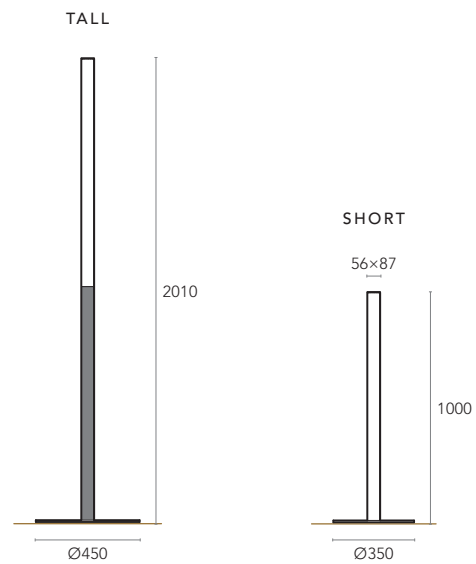



FEATURES

MOUNTING

Floor

LIGHT SOURCE

LED
3000K, 4000K
17W

MATERIALS & FINISHING

FIBERGLASS BODY
Glossy White, Black, Red

MOQ - Minimum Order Quantity
4 units

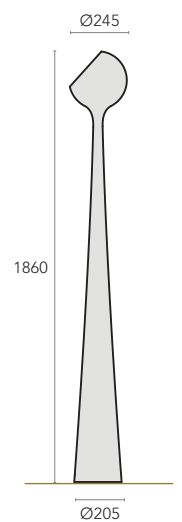

SNUPY



DESIGN BY ALBINO MIRANDA

Elegance that defies imagination.

Combining elegance, simplicity and LED technology, this outstanding floor standing lamp stimulates the imagination in any special corner of your home, creating a warm and subtle atmosphere. Available in three standard glossy finishes – red, black or white – that can be customised with any other colour to give each environment a reassuring and unique identity. With delicate and curved forms, this stunning lamp will bring a new life to your home decor.

SUNSET



SUNSET

See-through lighting.

Floor standing lamp made of shaped and powder coated steel wire, showing an almost transparent design that adds an avant-garde touch to rooms. The metal structure filters the light by creating a particular lighting effect in the environment, while its wire nature means it doesn't block views across the area.

In addition to the standard black finish, SUNSET can be customised with any other colour to fit your interior design concept. It's a floor standing lamp that easily integrates into any modern style decor in residential and office environments.



FEATURES

MOUNTING

Floor

LIGHT SOURCE

E27
1 × MAX 60W

MATERIALS & FINISHING

STEEL BODY
Matt Black

MOQ - Minimum Order Quantity
20 units

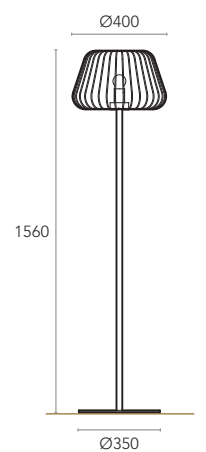



TABLE

KLLAVE



KLLAVE

Music is in the air...

With design inspired in the musical world, this lamp combines technology and innovation with craftsmanship and metal working tradition. This bedside table lamp with a brass handmade structure features a chromed finish, adding a touch of modernity and making it fully adaptable to any decorative style. Seeing as this is a bespoke lighting design, every feature can be altered to meet your expectations and requests. The unique details and customisation possibilities of the KLLAVE bedside table lamp, making it the ideal choice to be used in a lighting hospitality project.



FEATURES

MOUNTING

Table

LIGHT SOURCE

E27
1× MAX 60W

MATERIALS & FINISHING

BRASS BODY
Chrome

LAMPSHADE
Beige Camelot

MOQ - Minimum Order Quantity
50 units

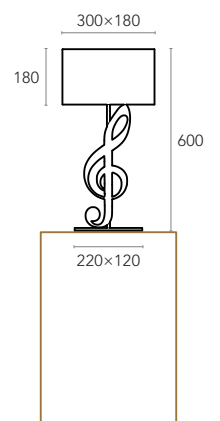



SWIRL

FEATURES

MOUNTING
Table

LIGHT SOURCE
E27
1× MAX 60W

MATERIALS & FINISHING
STEEL BODY
Matt White, Black
LAMPSHADE
White, Black Schintz
Grey Argent

MOQ - Minimum Order Quantity
50 units

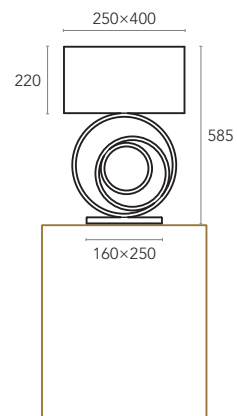

SWIRL

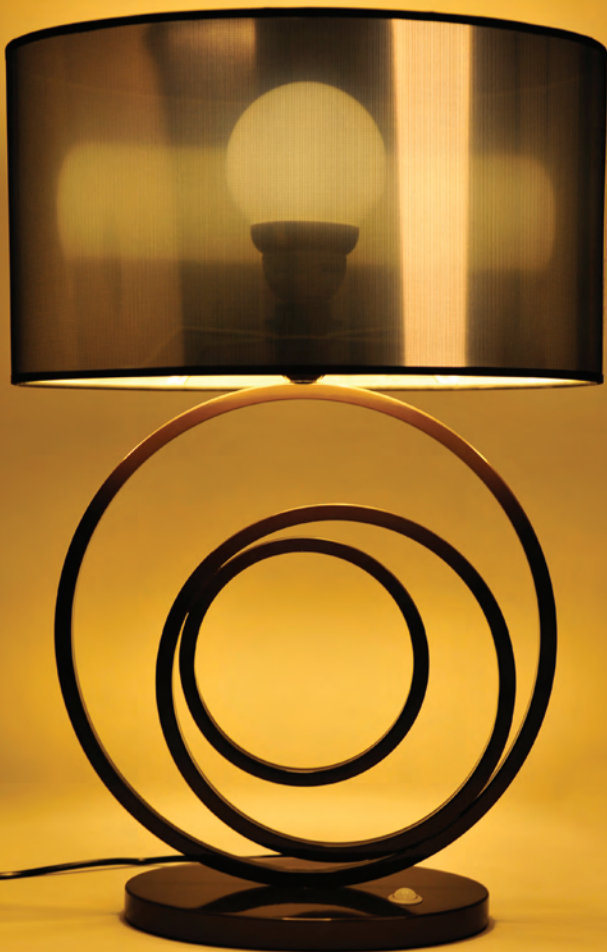

Spiralling patterns of elegance.

With a design inspired by twisting patterns, this lamp combines technology with craftsmanship and metal working tradition. The handmade structure is supported on a weighted base that includes a switch, conveniently located for easy use. It is charmingly complemented by a large lampshade offering upper and lower light distribution, fitted with a protective top cover providing cosy lighting. In addition to the wide range of standard fabrics and finishes available, SWIRL can be fully customised to suit your interior design project. The stylish design provided by the spiral structure will make this unique table lamp stand out in a lighting hospitality project.

BONN 01



Discovery, charm and refinement.

With a strong architectural presence the BONN light works perfectly within interiors that embrace the structure of a building. The structure is handmade in aluminium covered by a gold finish, seductively complemented by a silk lampshade of generous dimensions. This table lamp can be customised upon request to add a more personalised atmosphere to your interior design. It is a table lamp, very hard to miss, with almost 700 mm tall, making it the ideal choice for a classic living room design or in a lighting hospitality project.



FEATURES

MOUNTING

Table

LIGHT SOURCE

E27
1× MAX 60W

MATERIALS & FINISHING

ALUMINIUM BODY
Gold Painting

LAMPSHADE
Beige Pongé Silk

MOQ - Minimum Order Quantity
50 units

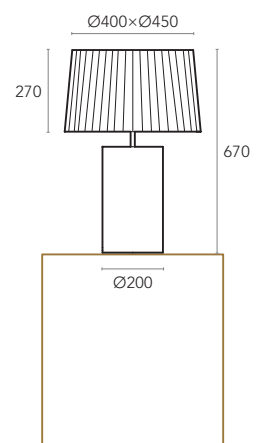



FEATURES

MOUNTING
Table

LIGHT SOURCE
E27
1× MAX 60W

MATERIALS & FINISHING
ALUMINIUM BODY
Gold Painting
LAMPSHADE
Beige Pongé Silk

MOQ - Minimum Order Quantity
50 units

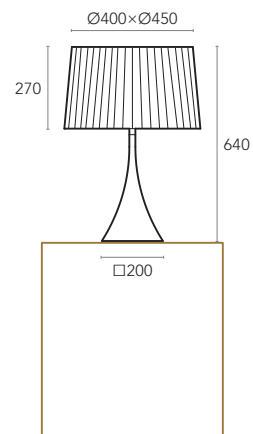

BONN 02



Exclusive value of unique details.

BONN table light is a strong design lamp with distinct features that make it stand out in any room setting. The structure is handmade in aluminium covered by a gold finish, seductively complemented by a silk lampshade of generous dimensions. This table lamp can be customised upon request to add a more personalised atmosphere to your interior design. It is a table lamp, very hard to miss, with almost 700 mm tall, making it the ideal choice for a classic living room design or in a lighting hospitality project.

DUNE



DUNE

Simple forms, distinct light.

The design of the DUNE table lamp balances the arrangement of simple forms and contrasting materials to create a feeling of lightness and harmony. Handmade in aluminium, the body is covered by a gold finish with an opal glass globe providing soft diffused light. The finish of the structure and base can be customised upon request with any other metal or RAL colour to fit your interior design concept. Is an elegant lighting solution for the home or hospitality sector. DUNE has a unique appeal that won't go unnoticed.



DUNE

FEATURES

MOUNTING
Table

LIGHT SOURCE
G9
1 × MAX 40W

MATERIALS & FINISHING
STEEL BODY
Gold Painting
DIFFUSER
Opal Glass

MOQ - Minimum Order Quantity
20 units

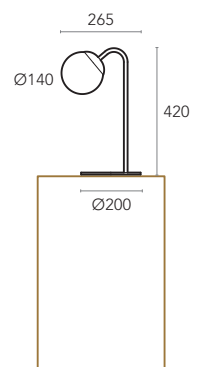



LINEFLUX

FEATURES

MOUNTING

Table

LIGHT SOURCE

LED
3000K, 4000K
6W (2x3W)

MATERIALS & FINISHING

STEEL STRUCTURE
Matt White, Matt Black
Chrome

MOQ - Minimum Order Quantity
20 units

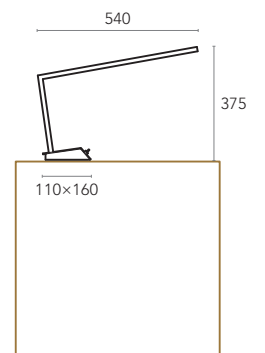

LINEFLUX



The differentiating model.

The sleek yet understated LINEFLUX task lamp joins modern design and seamless functionality to create a versatile and efficient light. Characterized by elegant straight lines balancing on a chrome mirror weighted base that includes a switch, conveniently located for a quick and easy use. It uses a reliable LED light source, ideal for localized lighting over desks and worktables.

SANTIAGO



DESIGN BY **ÁLVARO SIZA**

Bold expressiveness.

SANTIAGO is a perfect showcase for how elegant and sophisticated functional design can be. It's a table lamp available in three heights, with an opal PMMA diffuser and a brushed stainless steel structure that can be customised with any other metal or RAL colour to fit your needs. The diffuser guarantees max use of the LED light source, while offering a homogeneous light distribution. The top curved opal diffuser allows light to shine out and illuminate the ceiling, whilst the bottom diffuser provides great lighting effectiveness on working or reading surfaces.



SANTIAGO

FEATURES

MOUNTING
Table

LIGHT SOURCE
E27
2× MAX 60W

MATERIALS & FINISHING
STRUCTURE
Brushed Stainless Steel
DIFFUSER
Opal PMMA

DIMENSIONS
L: 700, 830, 1170

MOQ - Minimum Order Quantity
20 units

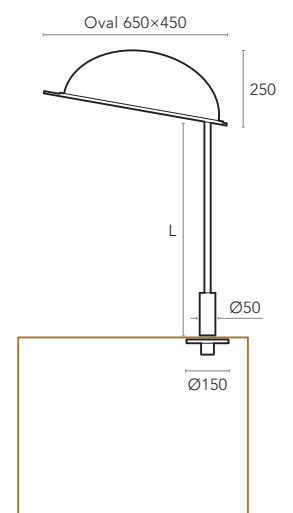



READING LIGHTS

FLEXILED



FLEXILED

Fully directional light.

A LED task light, ironically named to reflect its energy efficiency and functional design. Suitable as bedside table reading light or desk mounted for use in libraries and offices, FLEXILED can also be mounted on the bed head for use as task light in hotel rooms. The luminaire's flexible arm allows adjustment freedom to suit any lighting requirement. Fixes via recessing spike finished with a decorative cover plate. With a wide range of versions and variety of finishes available, FLEXILED is an elegant lighting solution for the home or hospitality sector.



FLEXIBLED

FEATURES

MOUNTING
Bedside Lamp

LIGHT SOURCE
LED
3000K, 4000K
Beam Angle 25°, 40°
1W, 2W
External Driver

MATERIALS & FINISHING

ALUMINIUM STRUCTURE
Matt White, Matt Black

BRASS STRUCTURE
Chrome
Gold

MOQ - Minimum Order Quantity
20 units

VERSIONS

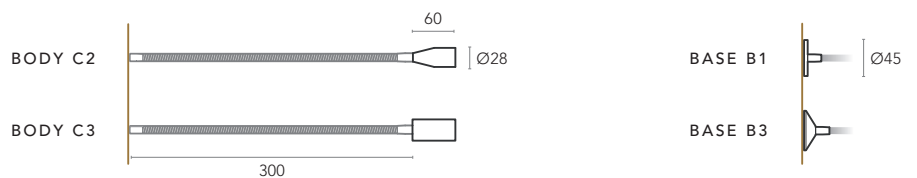



FEATURES

MOUNTING
Bedside Lamp

LIGHT SOURCE
LED
3000K, 4000K
Beam Angle 25°, 40°
1W, 2W

MATERIALS & FINISHING
ALUMINIUM STRUCTURE
Matt White, Matt Black

MOQ - Minimum Order Quantity
20 units

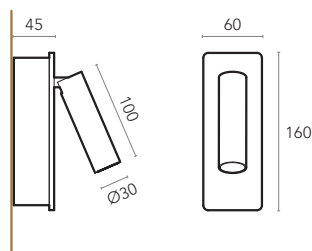

VERSIONS



ON/OFF SWITCH



USB PLUG

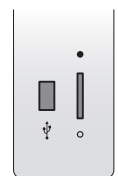

SWITCH + USB PLUG (*)

(*) Versions available for left or right bedside.

SOFTLED SF



Endowed with singularity.

Directional LED wall lamp suitable as support reading light or to highlight objects, surfaces or details. Composed by a base that includes a switch, conveniently located for a quick and easy use and a pivoting head allowing to direct the light precisely where it is needed.

Light unit with integrated lens optics for a low-glare pinpoint reading light. SOFTLED is an elegant lighting solution for the home or hospitality sector.

SOFTLED RC



SOFTLED RC

Essential presence.

Recessed wall lamp with directional LED light unit, suitable as reading light or to highlight objects. Composed by a base that includes a switch conveniently located for a quick and easy use and a pivoting head allowing to direct the light precisely where it is needed. Light unit with integrated lens optics for a low-glare pinpoint reading light. The unobtrusive structure enables the lamp to blend into the room even when not in use. SOFTLED is an elegant lighting solution for the home or hospitality sector.



SOFTLED RC

FEATURES

MOUNTING
Bedside Lamp

LIGHT SOURCE
LED
3000K, 4000K
Beam Angle 25°, 40°
1W, 2W

MATERIALS & FINISHING
ALUMINIUM STRUCTURE
Matt White, Matt Black

MOQ - Minimum Order Quantity
20 units

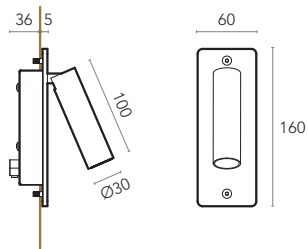

VERSIONS



ON/OFF SWITCH

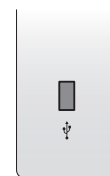

USB PLUG

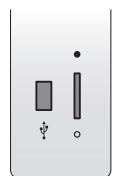

SWITCH + USB PLUG (*)

(*) Versions available for left or right bedside.



FEATURES

MOUNTING
Bedside Lamp

LIGHT SOURCE
LED
3000K, 4000K
Beam Angle 25°, 40°
1W, 2W
External Driver

MATERIALS & FINISHING
ALUMINIUM STRUCTURE
Matt White, Matt Black

MOQ - Minimum Order Quantity
20 units

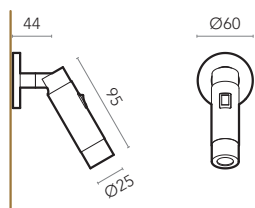

VERSIONS

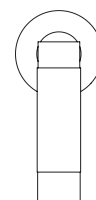

NO SWITCH

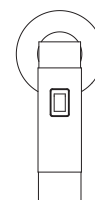

ON/OFF SWITCH

SOFTLED RO



Glare-free, adjustable light.

Deceptively simple in design, the SOFTLED performs the three key functions of reach, adjustability and glare-free illumination. Combining a small and unobtrusive base with a pivoting head that allows to direct the light precisely where it is needed. Light unit with integrated lens optics for a low-glare pinpoint reading light which can be rotated and swivelled, enabling the lighting effect to be easily adjusted. SOFTLED is an elegant lighting solution for the home or hospitality sector.

STAR



STAR

Design simplicity and perfect duality.

The STAR elegantly combines ambient lighting with the directional functionality of an LED reading light. Suitable as bedside table reading light which can be mounted on either side of the bed providing a soft, soothing and uniform glow, while its flexible arm enables full adjustability of the beam to illuminate the task at hand. The finishes can be customised with any metal or RAL colour of your choosing, adding a more personalised and welcoming atmosphere to your interior design. STAR is an elegant lighting solution for the home or hospitality sector.



STAR

FEATURES

MOUNTING
Bedside Lamp

LIGHT SOURCE
READING LIGHT
LED
3000K, 4000K
Beam Angle 25°, 40°
1W, 2W

AMBIENT LIGHT
LED
3000K, 4000K
3W

MATERIALS & FINISHING
ALUMINIUM STRUCTURE
Matt White, Matt Black
DECORATIVE RING
Chrome

MOQ - Minimum Order Quantity
20 units

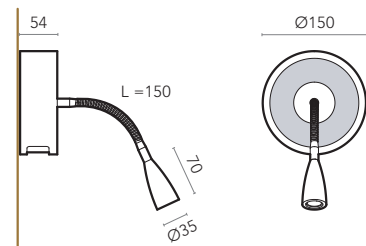



TAP

FEATURES

MOUNTING
Bedside Lamp

LIGHT SOURCE
LED
3000K, 4000K
Beam Angle 25°, 40°
1W, 2W
External Driver

MATERIALS & FINISHING
STRUCTURE
Brushed Brass

MOQ - Minimum Order Quantity
20 units

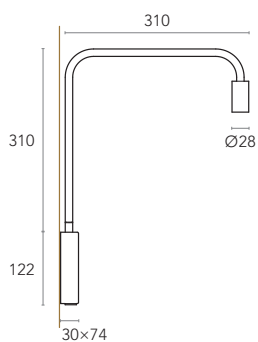

VERSIONS

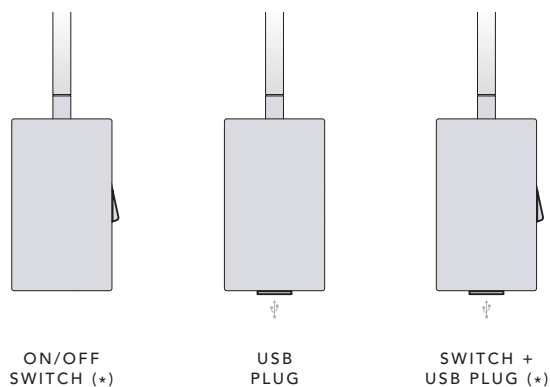

(*) Versions available for left or right bedside.

TAP

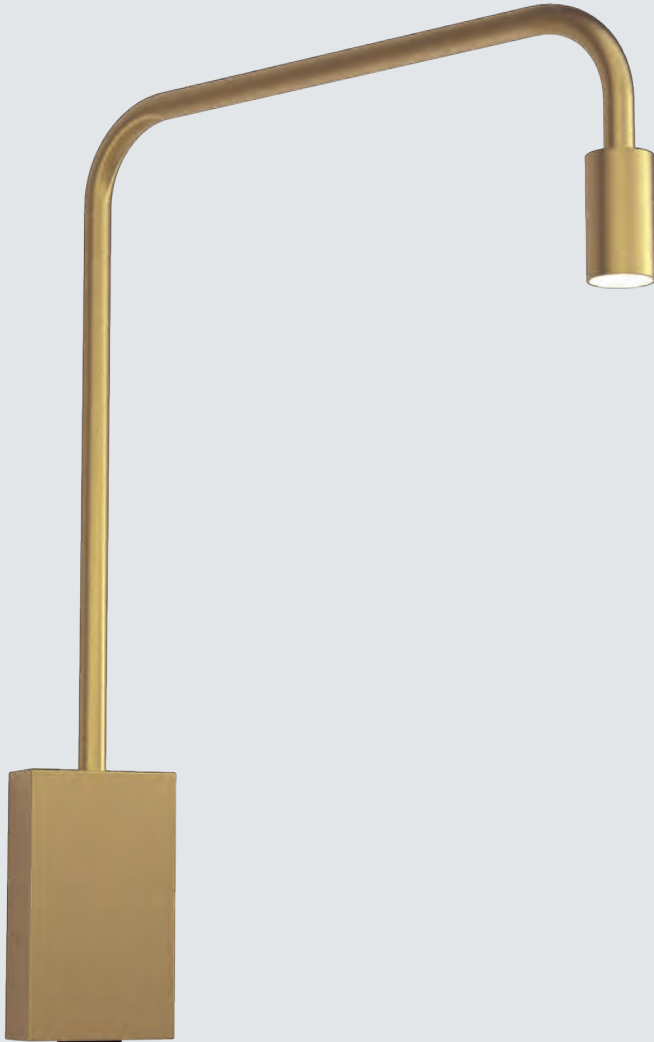

Discrete light segments.

Subtle straightforward design, the TAP bedside reading light maintains an architectural purity, but enables the full functionality of a directional LED reading light. Suitable as bedside lamp which can be mounted on either side of the bed, TAP combines a small and unobtrusive base with an adjustable arm, enabling the lighting effect to be easily adjusted. Light unit with integrated lens optics for a low-glare pinpoint reading light.

The finishes can be customised with any metal or RAL colour of your choosing, adding a more personalised and welcoming atmosphere to your interior design. TAP is an elegant lighting solution essential at any hospitality project.



RECESSED

JAZZ



JAZZ

Blends into the room for architectural purity.

Ceiling recessed-mounted luminaire characterized by its shape and finish, which make it unobtrusive as well as bold and able to differentiate the space in which it is placed. The JAZZ offers a lighting solution suitable for integration with minimal visual impact into any contemporary environment, while creating relaxed and warm atmospheres for hotels, restaurants and indoor walkthrough areas.

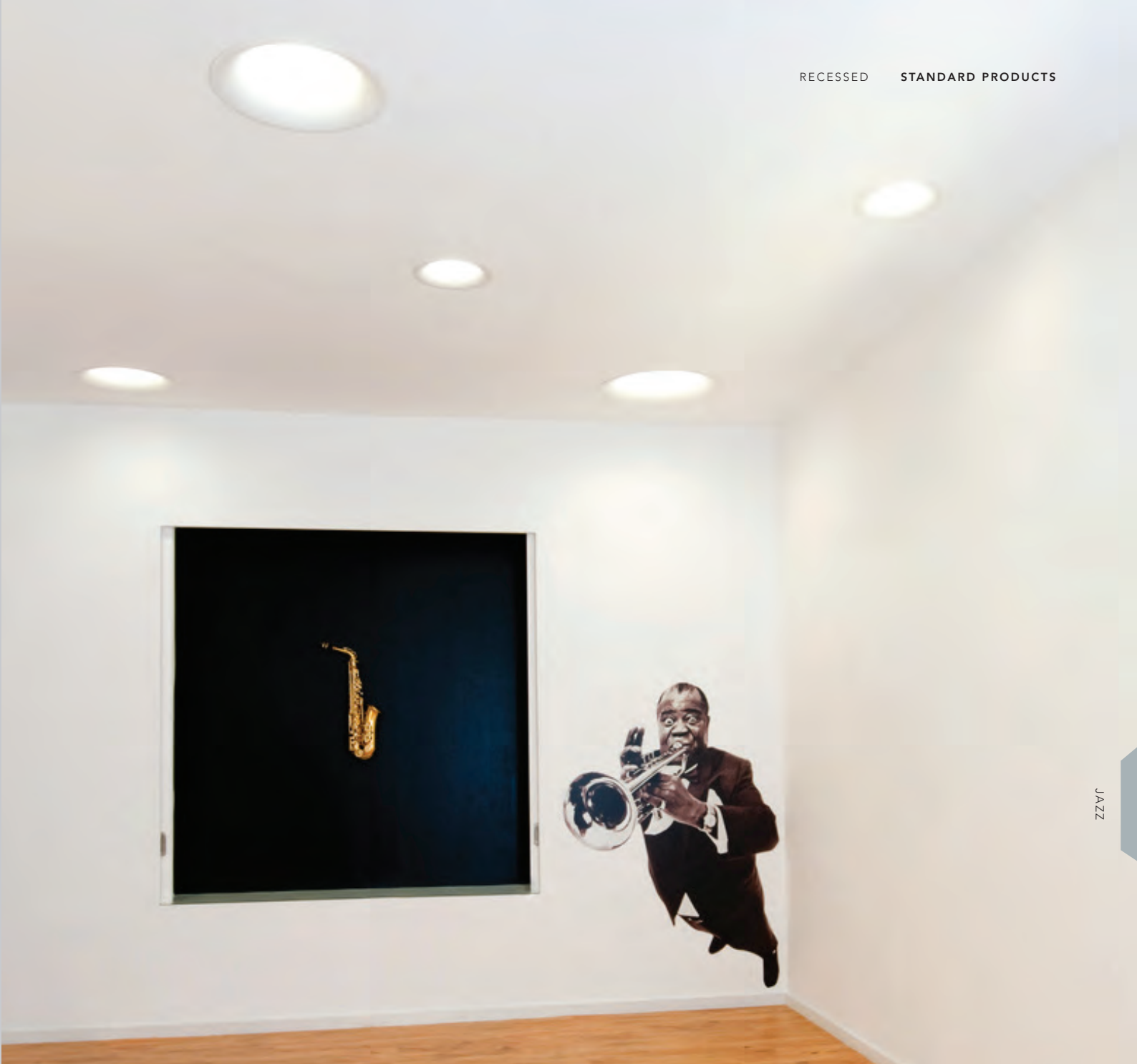

JAZZ

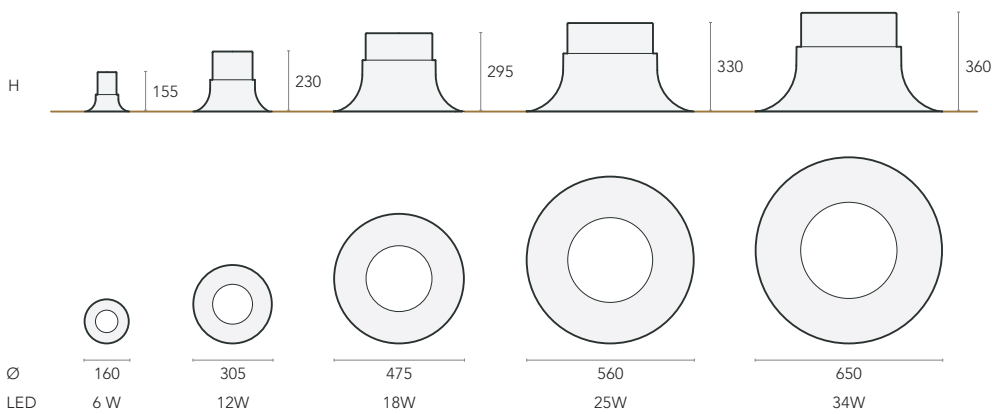

FEATURES

MOUNTING
Recessed

LIGHT SOURCE
LED
3000K, 4000K

MATERIALS & FINISHING
ALUMINIUM BODY
Matt White

DIFFUSER
Opal Polycarbonate

MOQ - Minimum Order Quantity
20 units



KNIK

SYMMETRIC

ASYMMETRIC

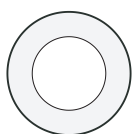

Ø400

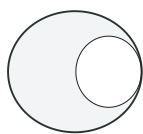

Oval 410x450

FEATURES

MOUNTING
Trimless

LIGHT SOURCE
LED
3000K, 4000K
20W

MATERIALS & FINISHING
ALUMINIUM BODY
Matt White
DIFFUSER
Opal PMMA

MOQ - Minimum Order Quantity
20 units

KNIK



DESIGN BY TIAGO DA SILVA DIAS

Skylight lighting system.

Recessed-mounted luminaire that mimics a skylight, providing a pleasant setting which promises to turn any room into a reference area. The minimalist architectural structure enables ceiling integration with minimal visual impact while the rearward LED position avoids glare, providing a greater sense of visual comfort.

O-LIGHT



O-LIGHT

Subtle light ring.

Recessed-mounted luminaire with a halo lighting effect around its central disc, for a stylish and contemporary look. The O-LIGHT subtle design easily integrates into the architecture, enabling it to blend into the room even when not in use. It uses the latest LED technology to create a glow of light around the central disc, for a beautiful lighting effect that is also an effective lighting solution. With an appeal that won't go unnoticed, O-LIGHT is ideal for the home or hospitality sector.



O-LIGHT

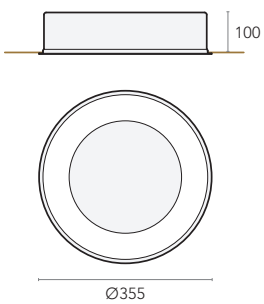

FEATURES

MOUNTING
Recessed

LIGHT SOURCE
LED
3000K, 4000K
21W

MATERIALS & FINISHING
ALUMINIUM BODY
Matt White
DIFFUSER
Opal PMMA

MOQ - Minimum Order Quantity
20 units



EXTERIOR



FEATURES

MOUNTING

Floor

LIGHT SOURCE

LED
2700K, 3000K, 4000K
5W, 10W

MATERIALS & FINISHING

ALUMINIUM STRUCTURE
Textured Brown

DIFFUSER
Clear PMMA

MOQ - Minimum Order Quantity
20 units

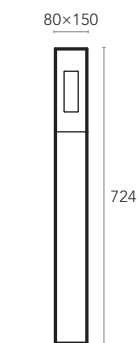

TREE



DESIGN BY CARLOS CASTANHEIRA

Lighting that blends into the urban environment.

Slender, minimalist design bollard with asymmetric light distribution designed to ensure high visual comfort, while integrating brilliantly with its surroundings. The light from these luminaires is directed downwards and fully shielded above the horizontal providing a comfortable visual guidance suitable for walkways and entrance areas in garden and residential areas. The highest degree of illuminance is achieved in the immediate vicinity of the luminaire. The TREE bollard is available in textured brown standard finishing that can be customised according to your needs and requests.

LUNA



LUNA

Organic interpretation.

Bold concept that integrates the nobility of the wood pole with the solid presence of the stainless steel inserts, in a bollard that is robust, simple and organic. Lighting system designed for use with LED light sources to ensure high visual comfort and pleasantly uniform light effects. The LUNA bollard is a minimalist design with 360° light emission, providing a comfortable visual guidance suitable for lighting promenades and footpaths in residential areas. These durable and attractively designed luminaires can be used individually or in groups around buildings.



LUNA

FEATURES

MOUNTING

Floor

LIGHT SOURCE

LED
3000K, 4000K
9W

MATERIALS & FINISHING

STRUCTURE
Brushed Stainless Steel
Thermowood

DIFFUSER
Opal Polycarbonate

MOQ - Minimum Order Quantity
20 units

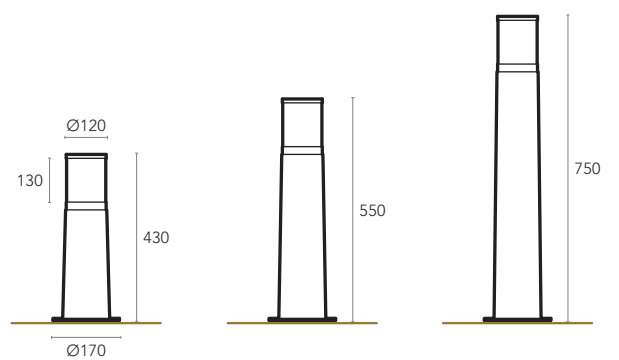

ALL DIMENSIONS IN MILLIMETERS



FEATURES

MOUNTING
Wall

LIGHT SOURCE
LED
3000K, 4000K, 5000K
38W, 54W

MATERIALS & FINISHING

STEEL STRUCTURE
Matt Black

DIFFUSER
Opal Tempered Glass

MOQ - Minimum Order Quantity
30 units

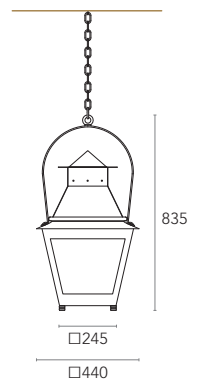

TEMPLUS



Heritage lighting, modern performance.

Inspired by urban lanterns of the 19th Century, the TEMPLUS collection pays homage to a more historical than modern concept design. This lanterns were developed to re-create the appearance and effect of the traditional gaslight lanterns, updated with LED technology to meet the demands of modern lighting performance - improved light distribution, reduced upwards light emission, reliability and high energy efficiency - while maintaining a nostalgic look. The TEMPLUS lanterns are stylish luminaires which impress by their high-quality materials and craftsmanship, combined with modern lighting technology.



SIGNAGE



FEATURES

MOUNTING
Wall

LIGHT SOURCE
LED
3000K, 4000K
4W
External Driver

MATERIALS & FINISHING

ALUMINIUM STRUCTURE
Matt Black
Brushed Stainless Steel
Brushed Brass

DIFFUSER
Opal PMMA

MOQ - Minimum Order Quantity
20 units
Same base allowing different pictograms.

Other pictograms available on request.

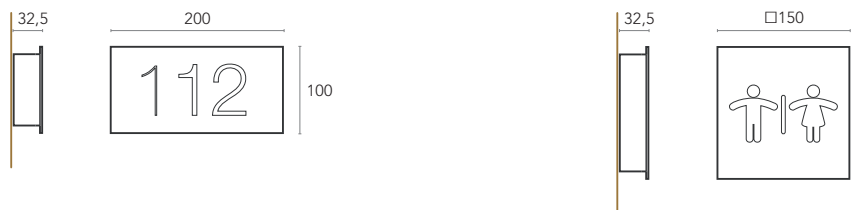

VERSIONS

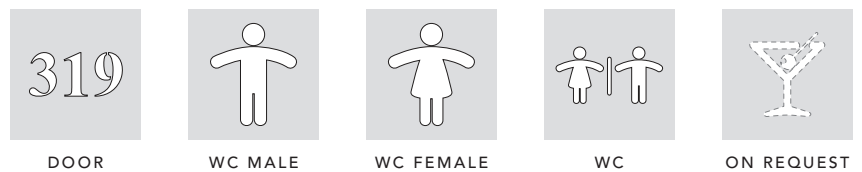

SIGNAGE



Signage personalized to your needs.

Illuminated signage signs are essential for every commercial building, helping to guide staff, visitors and customers. The presented models are backlit edge-lit signs that work well in any application that requires an elegant architectural signage system.

The bespoke nature of the illuminated signage allows the designer the opportunity to personalise it to sit in fully with their overall design and can feature any font, colour, pattern or logo to suit client's style or the graphic design of the hotel. Those also have the added benefit of working as a subtle secondary lighting source, softly illuminating the wall and defining the corridor space.



MIRROR LIGHTS

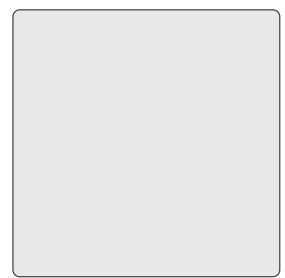
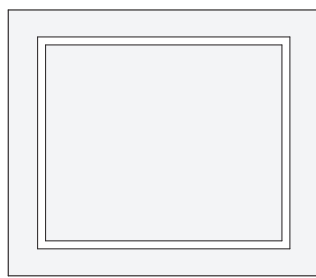
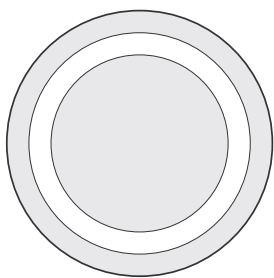



FEATURES

MOUNTING
Wall

LIGHT SOURCE
LED

MATERIALS & FINISHING
Mirror Glass

OPTIONS
Demister Function

MOQ - Minimum Order Quantity
20 units of each model

Dimensions available on request.

MIRRORS

Right light to reveal your true self.

Wall mirrors are essential items at every bathroom, being the illuminated mirror clearly the best option.

Designed specifically for bathroom use, all models have an IP44 rating, suitable for bathroom zone 2 and outside. Those LED mirror can be fitted with built in demister function, to keep the crystal clear whenever you need it. The mirrors combine with a variety of home and hotel decor styles.

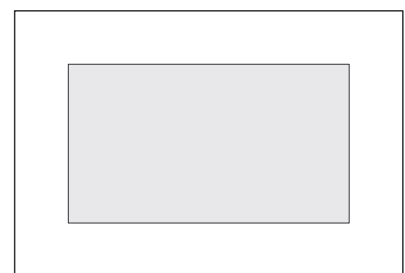
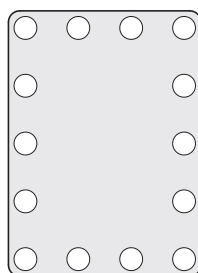
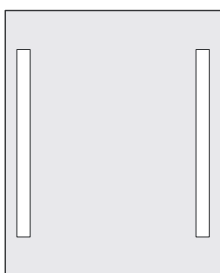

A-Z General Index

A	pag
AMELIE	028
ANAHORY	048
ARCH	090

B	pag
BONN 01	172
BONN 02	174

C	pag
CHERRY	106
CHESS	120
CIVETTA	096
COCO	130
CONE	146
CRISTAL LOVE	038
CUBO	018
CYLIX	046

D	pag
DIAMOND	042
DIMPLE	016
DOURO	076
DREAM	036
DUNE	176
DYNASTY	030

E	pag
ECO	156
EDGY	144
EVA	100

F	pag
FIORI	150
FLEX	110
FLEXILED	184
FLOWIN	128

G H I	pag
GALERIA	152
GARLAND	140
GOCCIA	034
GRANDI	132
GRATIA	102

J	pag
JAZZ	198

K	pag
KLLAVE	168
KNIK	200
KOBBER 02	022
KOBBER 03	024
KRIZ	088

L	pag
LEAF	116
LINEFLUX	178
LUNA	208
LUSH	032

M	pag
MEET	154
MELI	098
MIRRORS	218
MUSE	108

N	pag
NATUR	104
NIU	058
NOA	062

O	pag
O-LIGHT	202

P	pag
POP-UP	026
POZI	118

Q	pag
QUEEN	040

R	pag
RAY	136
ROCHÉ	126
RUBY	072

S	pag
SANTIAGO	180
SATURNO	020
SCAPES	160
SIGNAGE	214
SNUPY	162
SOFTLED RC	188
SOFTLED RO	190
SOFTLED SF	186
SOLARIS	044
SPAZZO	092
SPELL	142
SPHERE	068
STAR	192
STONE	114
STYLUZ	080
SUNSET	164
SWIRL	170
SYN	054

T U	pag
TABRIGA	134
TAP	194
TEMPLUS	210
TORCH	148
TR3	084
TREE	206

V	pag
VERSITY	094
VOID	138

W X Y Z	pag
WAVE	122

Reference Projects



5 ^{years}
guarantee

Five-year guarantee

Climar products are covered by a 5-year manufacturer's guarantee in accordance with the terms of guarantee at www.climarlighting.com.

Information in this catalogue was valid at the time of printing, is non-binding, and should be used for information purposes only. We reserve the right to make changes to our products at any time. For regularly updated data, technical and photometric information, quality certificates and product data sheets please refer to our website www.climarlighting.com.

This catalogue nullifies all previous versions and it may be changed without notice.

Acknowledgements

A Padaria Portuguesa
Academia de Ginástica de Guimarães
BessaHotel Baixa
Arch. Álvaro Siza
Arch. Carlos Castanheira
Catorze 21 Restaurant & Wine Bar
CONRAD Hotel Algarve
NAU - Hotel Governador
PCI - Design Factory Aveiro
Saint-Jacques de la Lande Church
The Oitavos
The Siza House - Taifong Golf Club
XPT - Alojamento e Restauração

Concept / Graphic Design

Climar Lighting

Photo

Climar Lighting

Print

Orgal Impressores

Copyright © **Climar Lighting**

All rights reserved.

03.2020 - First Edition
DVM.252.20.1

Made in Portugal

For the latest edition of the Catalogue,
please visit www.climarlighting.com.

Climar
L I G H T I N G

Climar - Indústria de Iluminação, S.A.

Headquarters

Rua Estrada Real, 50
3750-866 Águeda - Portugal

Lisbon Office

Rua Amorim, 2
1950-022 Lisboa - Portugal

t +351 234 690 330 | **m** +351 915 599 110
e geral@climar.pt

London Office

31 – 35 Kirby Street
London EC1N 8TE - UK

t +44 (0)20 7492 1707 | **m** +44 (0)749 637 8770
e info@climarlighting.co.uk

HOSPITALITY

Cofinanciado por:



climarlighting.com